



PROFESSIONAL DIGITAL TWO-WAY RADIO

**MOTOTRBO™**

**DM4400/DM4400e, DM4401/DM4401e**  
**NUMERIC DISPLAY MOBILE RADIO**

---

**USER GUIDE**

en-US



**FEBRUARY 2021**

© 2021 Motorola Solutions, Inc. All rights reserved.



**68012007017-GP**

# Contents

---

|  |    |   |    |
|--|----|---|----|
| Important Safety Information.....                            | 14 | 3.1.5 Switching from WAVE Mode to<br>Radio Mode ..... | 25 |
| Software Version.....  | 15 | Part I: Capacity Max.....                             | 26 |
| Copyrights.....  | 16 | 4.1 Push-To-Talk (PTT) Button.....                    | 26 |
| Computer Software Copyrights.....                            | 18 | 4.2 Programmable Buttons.....                         | 26 |
| Radio Care.....  | 19 | 4.3 Assignable Radio Functions.....                   | 27 |
| Chapter 1: Getting Started.....                              | 21 | 4.4 Assignable Settings or Utility Functions.....     | 28 |
| 1.1 Turning the Radio On.....                                | 21 | 4.5 Status Indicators.....                            | 29 |
| 1.2 Turning the Radio Off.....                               | 21 | 4.5.1 LED Indicator.....                              | 29 |
| 1.3 Adjusting the Volume.....                                | 21 | 4.5.2 Tones.....                                      | 30 |
| Chapter 2: Radio Controls.....                               | 22 | 4.5.2.1 Audio Tones.....                              | 30 |
| 2.1 Volume/Channel Knob.....                                 | 22 | 4.5.2.2 Indicator Tones.....                          | 30 |
| Chapter 3: WAVE.....   | 23 | 4.6 Registration.....                                 | 31 |
| 3.1 WAVE OnCloud/OnPremise.....                              | 23 | 4.7 Zone and Channel Selections.....                  | 32 |
| 3.1.1 Switching from Radio Mode to<br>WAVE Mode.....         | 23 | 4.7.1 Selecting Zones .....                           | 32 |
| 3.1.2 Making WAVE Group Calls.....                           | 24 | 4.7.2 Selecting a Call Type.....                      | 32 |
| 3.1.3 Receiving and Responding to<br>WAVE Group Calls.....   | 24 | 4.7.3 Selecting a Site.....                           | 33 |
| 3.1.4 Receiving and Responding to<br>WAVE Private Calls..... | 24 | 4.7.4 Roam Request.....                               | 33 |
|  |    | 4.7.5 Site Lock On/Off.....                           | 34 |
|  |    | 4.7.6 Site Restriction.....                           | 34 |
|  |    | 4.7.7 Site Trunking .....                             | 34 |
|  |    | 4.8 Calls.....  | 35 |

|   |    |  |    |
|---|----|--|----|
| 4.8.1 Group Calls.....  | 35 | 4.8.5.3 Responding to Phone<br>Calls as All Calls.....     | 44 |
| 4.8.1.1 Making Group Calls.....                                     | 35 | 4.8.5.4 Responding to Phone<br>Calls as Group Calls.....   | 45 |
| 4.8.1.2 Responding to Group<br>Calls.....                           | 36 | 4.8.5.5 Responding to Phone<br>Calls as Private Calls..... | 45 |
| 4.8.2 Broadcast Call .....  | 37 | 4.8.6 Initiating Transmit Interrupt.....                   | 46 |
| 4.8.2.1 Making Broadcast Calls ..                                   | 37 | 4.8.7 Call Preemption.....                                 | 46 |
| 4.8.2.2 Receiving Broadcast<br>Calls .....                          | 37 | 4.8.8 Voice Interrupt.....                                 | 46 |
| 4.8.3 Private Call.....   | 38 | 4.8.8.1 Enabling Voice Interrupt...47                      |    |
| 4.8.3.1 Making Private Calls.....                                   | 38 | 4.9 Advanced Features.....                                 | 47 |
| 4.8.3.2 Making a Private Call<br>with a One Touch Call Button ..... | 39 | 4.9.1 Call Queue.....                                      | 47 |
| 4.8.3.3 Receiving Private Calls....                                 | 40 | 4.9.2 Priority Call.....                                   | 48 |
| 4.8.3.4 Accepting Private Calls ...                                 | 40 | 4.9.3 Talkgroup Scan .....                                 | 49 |
| 4.8.3.5 Declining Private Calls ....                                | 40 | 4.9.3.1 Turning Talkgroup Scan<br>On or Off.....           | 49 |
| 4.8.4 All Calls .....   | 41 | 4.9.4 Receive Group List.....                              | 49 |
| 4.8.4.1 Making All Calls .....                                      | 41 | 4.9.5 Priority Monitor.....                                | 49 |
| 4.8.4.2 Receiving All Calls .....                                   | 41 | 4.9.6 Multi-Talkgroup Affiliation.....                     | 50 |
| 4.8.5 Phone Calls.....  | 42 | 4.9.7 Talkback .....                                       | 50 |
| 4.8.5.1 Making Phone Calls.....                                     | 42 | 4.9.8 Bluetooth®.....                                      | 51 |
| 4.8.5.2 Making Phone Calls with<br>the Programmable Button .....    | 43 |  |    |











|  |    |   |    |
|--|----|---|----|
| 4.9.8.1 Connecting to Bluetooth Devices.....   | 52 | 4.9.13.1 Making Call Alerts.....                            | 56 |
| 4.9.8.2 Disconnecting from Bluetooth Devices.....                                      | 52 | 4.9.13.2 Responding to Call Alerts .....                    | 56 |
| 4.9.8.3 Switching Audio Route between Internal Radio Speaker and Bluetooth Device..... | 52 | 4.9.14 Mute Mode.....                                       | 56 |
| 4.9.9 Multi-Site Controls.....   | 53 | 4.9.14.1 Turning On Mute Mode..                             | 56 |
| 4.9.9.1 Enabling Manual Site Search.....   | 53 | 4.9.14.2 Exiting Mute Mode.....                             | 57 |
| 4.9.9.2 Site Lock On/Off.....  | 53 | 4.9.15 Emergency Operation.....                             | 57 |
| 4.9.10 Home Channel Reminder.....  | 53 | 4.9.15.1 Sending Emergency Alarms.....                      | 58 |
| 4.9.10.1 Muting the Home Channel Reminder.....   | 54 | 4.9.15.2 Sending Emergency Alarms with Call.....            | 59 |
| 4.9.10.2 Setting New Home Channels.....  | 54 | 4.9.15.3 Sending Emergency Alarms with Voice to Follow..... | 61 |
| 4.9.11 Remote Monitor.....   | 54 | 4.9.15.4 Receiving Emergency Alarms .....                   | 62 |
| 4.9.11.1 Initiating Remote Monitor.....  | 54 | 4.9.15.5 Responding to Emergency Alarms with Call.....      | 63 |
| 4.9.12 Call Indicator Settings.....  | 55 | 4.9.15.6 Exiting Emergency Mode.....                        | 63 |
| 4.9.12.1 Escalating Alarm Tone Volume.....   | 55 | 4.9.16 Status Message.....                                  | 63 |
| 4.9.13 Call Alert Operation.....   | 55 | 4.9.16.1 Sending Status Messages.....                       | 64 |
|  |    | 4.9.17 Text Messaging .....                                 | 64 |



|                                       |    |   |    |
|---------------------------------------|----|---|----|
| 4.9.17.1 Quick Text Messages ...      | 65 | 4.9.26 Dynamic Group Number               |    |
| 4.9.17.1.1 Sending Quick              |    | Assignment (DGNA).....                    | 71 |
| Text Messages .....                   | 65 | 4.9.26.1 Making DGNA Calls.....           | 71 |
| 4.9.18 Privacy.....                   | 65 | 4.9.26.2 Making Non-DGNA                  |    |
| 4.9.18.1 Turning Privacy On or        |    | Calls.....                                | 72 |
| Off.....                              | 66 | 4.9.26.3 Receiving and                    |    |
| 4.9.19 Response Inhibit.....          | 66 | Responding to DGNA Calls.....             | 72 |
| 4.9.19.1 Turning Response             |    | 4.10 Utilities.....                       | 72 |
| Inhibit On or Off.....                | 66 | 4.10.1 Power Levels.....                  | 72 |
| 4.9.20 Stun/Revive.....               | 67 | 4.10.1.1 Setting Power Levels....         | 73 |
| 4.9.21 Radio Kill.....                | 67 | 4.10.2 Turning Radio Tones/Alerts On      |    |
| 4.9.22 Lone Worker.....               | 67 | or Off.....                               | 73 |
| 4.9.23 Password Lock.....             | 68 | 4.10.3 Turning Horns/Lights On or Off ... | 73 |
| 4.9.23.1 Accessing the Radio by       |    | 4.10.4 Turning Public Address System      |    |
| Using Password.....                   | 68 | On or Off.....                            | 74 |
| 4.9.23.2 Unlocking Radios in          |    | 4.10.5 Turning External Public Address    |    |
| Locked State.....                     | 69 | System On or Off.....                     | 74 |
| 4.9.24 Over-the-Air Programming ..... | 69 | 4.10.6 Turning Voice Announcement         |    |
| 4.9.25 Wi-Fi Operation.....           | 69 | On or Off .....                           | 75 |
| 4.9.25.1 Turning Wi-Fi On or Off..    | 70 | 4.10.7 Turning Option Board On or Off...  | 75 |
| 4.9.25.2 Connecting to a              |    | 4.10.8 Text-to-Speech.....                | 75 |
| Network Access Point.....             | 70 | 4.10.8.1 Setting Text-to-Speech..         | 76 |







|   |    |  |    |
|---|----|--|----|
| 4.10.9 Turning Intelligent Audio On or Off.....                         | 76 | 5.1.4 Switching Between Connect Plus and Non-Connect Plus Modes..... | 82 |
| 4.10.10 Turning the Acoustic Feedback Suppressor Feature On or Off..... | 76 | 5.2 Making and Receiving Calls in Connect Plus Mode.....             | 83 |
| 4.10.11 Turning Trill Enhancement On or Off.....                        | 76 | 5.2.1 Selecting a Site.....  | 83 |
| 4.10.12 Turning Global Navigation Satellite System On or Off.....       | 77 | 5.2.1.1 Roam Request.....  | 83 |
| Part II: Connect Plus.....  | 78 | 5.2.1.2 Site Lock On/Off.....  | 83 |
| 5.1 Additional Radio Controls in Connect Plus Mode.....                 | 78 | 5.2.2 Selecting a Zone.....  | 84 |
| 5.1.1 Push-To-Talk (PTT) Button.....                                    | 78 | 5.2.3 Using Multiple Networks.....                                   | 84 |
| 5.1.2 Programmable Buttons.....   | 78 | 5.2.4 Selecting a Call Type.....                                     | 84 |
| 5.1.2.1 Assignable Radio Functions.....                                 | 79 | 5.2.5 Receiving and Responding to a Radio Call.....                  | 85 |
| 5.1.2.2 Assignable Settings or Utility Functions.....                   | 80 | 5.2.5.1 Receiving and Responding to a Group Call.....                | 85 |
| 5.1.3 Identifying Status Indicators in Connect Plus Mode.....           | 80 | 5.2.5.2 Receiving and Responding to a Private Call.....              | 86 |
| 5.1.3.1 LED Indicator.....  | 81 | 5.2.5.3 Receiving a Site All Call... ..                              | 86 |
| 5.1.3.2 Indicator Tones.....  | 82 | 5.2.5.4 Receiving an Inbound Private Phone Call.....                 | 87 |
| 5.1.3.3 Alert Tones.....  | 82 | 5.2.5.5 Receiving an Inbound Phone Talkgroup Call.....               | 87 |
|   |    | 5.2.5.6 Inbound Phone Multi-Group Call.....                          | 87 |



- 5.2.6 Making a Radio Call.....87
  - 5.2.6.1 Making a Call ..... 88
    - 5.2.6.1.1 Making a Group Call..... 88
    - 5.2.6.1.2 Making a Private Call..... 88
    - 5.2.6.1.3 Making a Site All Call..... 89
    - 5.2.6.1.4 Making a Multi-group Call..... 90
  - 5.2.6.2 Making a Private Call with a One Touch Call Button..... 90
- 5.3 Advanced Features in Connect Plus Mode .....91
  - 5.3.1 Home Channel Reminder..... 91
  - 5.3.2 Auto Fallback..... 91
    - 5.3.2.1 Indications of Auto Fallback Mode.....92
    - 5.3.2.2 Making/Receiving Calls in Fallback Mode..... 92
    - 5.3.2.3 Returning to Normal Operation..... 93
  - 5.3.3 Scan.....93
    - 5.3.3.1 Starting and Stopping Scan..... 93
    - 5.3.3.2 Responding to a Transmission During a Scan..... 94
  - 5.3.4 Turning Scan On or Off..... 94
  - 5.3.5 Understanding Scan Operation..... 95
  - 5.3.6 Scan Talkback..... 95
  - 5.3.7 Editing Priority for a Talkgroup..... 96
  - 5.3.8 Call Indicator Settings..... 96
    - 5.3.8.1 Escalating Alarm Tone Volume..... 96
  - 5.3.9 Call Alert Operation..... 97
    - 5.3.9.1 Responding to Call Alerts ..... 97
    - 5.3.9.2 Making a Call Alert with the One Touch Access Button..... 97
  - 5.3.10 Mute Mode..... 97
    - 5.3.10.1 Turning On Mute Mode.. 98
    - 5.3.10.2 Exiting Mute Mode..... 98
  - 5.3.11 Emergency Operation..... 99
    - 5.3.11.1 Responding to an Emergency Call..... 100

|  |     |   |     |
|--|-----|---|-----|
| 5.3.11.2 Ignore Emergency Revert Call.....                                 | 100 | 5.3.15.1 Finding and Connecting to a Bluetooth Device.....                              | 106 |
| 5.3.11.3 Initiating an Emergency Call.....                                 | 101 | 5.3.15.2 Disconnecting from a Bluetooth Device.....                                     | 107 |
| 5.3.11.4 Initiating an Emergency Call with Voice to Follow.....            | 101 | 5.3.15.3 Switching Audio Route between Internal Radio Speaker and Bluetooth Device..... | 107 |
| 5.3.11.5 Initiating an Emergency Alert.....                                | 102 | 5.3.16 Wi-Fi Operation.....   | 107 |
| 5.3.11.6 Exiting Emergency Mode.....                                       | 102 | 5.3.16.1 Turning Wi-Fi On or Off.....   | 108 |
| 5.3.12 Text Messaging .....  | 103 | 5.3.16.2 Connecting to a Network Access Point.....                                      | 108 |
| 5.3.12.1 Sending Quick Text Messages with the One Touch Access Button..... | 103 | 5.3.17 Utilities.....   | 109 |
| 5.3.13 Privacy.....  | 104 | 5.3.17.1 Turning the Radio Tones/Alerts On or Off.....                                  | 109 |
| 5.3.13.1 Making a Privacy-Enabled (Scrambled) Call.....                    | 104 | 5.3.17.2 Setting the Power Level .....  | 109 |
| 5.3.14 Password Lock Features.....   | 105 | 5.3.17.3 Voice Announcement... ..   | 110 |
| 5.3.14.1 Accessing the Radio from Password.....                            | 105 | 5.3.17.4 Turning Horns/Lights On or Off.....  | 110 |
| 5.3.14.2 Unlocking the Radio from Locked State.....                        | 105 | 5.3.17.5 Intelligent Audio.....   | 111 |
| 5.3.15 Bluetooth Operation.....  | 106 | 5.3.17.6 Turning the Acoustic Feedback Suppressor Feature On or Off.....                | 111 |

|   |     |   |     |
|---|-----|---|-----|
| 5.3.17.7 Turning GNSS On or Off.....  | 111 | 6.10.1 Group Calls.....   | 122 |
| Part III: Other Systems.....  | 112 | 6.10.1.1 Making Group Calls.....  | 122 |
| 6.1 Push-To-Talk Button.....  | 112 | 6.10.1.2 Responding to Group Calls.....   | 122 |
| 6.2 Programmable Buttons.....   | 112 | 6.10.2 Private Calls  .....                              | 123 |
| 6.2.1 Assignable Radio Functions.....   | 113 | 6.10.2.1 Making Private Calls  .....                     | 123 |
| 6.2.2 Assignable Settings or Utility Functions.....   | 115 | 6.10.2.2 Responding to Private Calls  .....              | 124 |
| 6.3 Status Indicators.....  | 115 | 6.10.3 All Calls.....   | 125 |
| 6.3.1 LED Indicators .....  | 115 | 6.10.3.1 Receiving All Calls.....   | 125 |
| 6.3.2 Tones.....  | 116 | 6.10.3.2 Making All Calls.....  | 125 |
| 6.3.2.1 Indicator Tones.....  | 116 | 6.10.4 Selective Calls  .....                            | 126 |
| 6.3.2.2 Audio Tones.....  | 117 | 6.10.4.1 Making Selective Calls.....  | 126 |
| 6.4 Conventional Analog and Digital Modes....   | 117 | 6.10.4.2 Responding to Selective Calls  .....            | 126 |
| 6.5 Icon Information.....   | 118 | 6.10.5 Phone Calls  .....                                | 127 |
| 6.6 IP Site Connect.....  | 118 | 6.10.5.1 Making Phone Calls  .....                       | 127 |
| 6.7 Capacity Plus—Single-Site  ..... | 119 | 6.10.5.2 Responding to Phone Calls as Group Calls  ..... | 128 |
| 6.8 Capacity Plus—Multi-Site  .....  | 119 | 6.10.5.3 Responding to Phone Calls as All Calls  .....   | 129 |
| 6.9 Zone and Channel Selections.....  | 120 |   |     |
| 6.9.1 Selecting Zones .....   | 120 |   |     |
| 6.9.2 Selecting Channels.....   | 121 |   |     |
| 6.10 Calls.....   | 121 |   |     |

|   |     |   |     |
|---|-----|---|-----|
| 6.10.5.4 Responding to Phone<br>Calls as Private Calls  .....                | 129 | 6.10.10 Open Voice Channel Mode<br>(OVCM).....          | 133 |
| 6.10.6 Initiating Transmit Interrupt  ...                                    | 129 | 6.10.10.1 Making OVCM Calls...                          | 134 |
| 6.10.7 Talkaround.....  | 130 | 6.10.10.2 Responding to OVCM<br>Calls.....              | 134 |
| 6.10.7.1 Toggling Between<br>Repeater and Talkaround<br>Modes.....  | 130 | 6.11 Advanced Features.....                             | 135 |
| 6.10.8 Broadcast Voice Calls.....   | 130 | 6.11.1 Home Channel Reminder.....                       | 135 |
| 6.10.8.1 Making Broadcast<br>Voice Calls.....   | 131 | 6.11.1.1 Muting the Home<br>Channel Reminder.....       | 135 |
| 6.10.8.2 Making Broadcast<br>Voice Calls by Using the<br>Programmable Number Key .....  | 131 | 6.11.1.2 Setting New Home<br>Channels.....              | 135 |
| 6.10.8.3 Making Broadcast<br>Voice Calls by Using the Alias<br>Search  ..... | 131 | 6.11.2 Remote Monitor.....                              | 136 |
| 6.10.8.4 Receiving Broadcast<br>Voice Calls.....  | 132 | 6.11.2.1 Initiating Remote<br>Monitor.....              | 136 |
| 6.10.9 Unaddressed Calls.....   | 132 | 6.11.3 Scan Lists.....                                  | 136 |
| 6.10.9.1 Making Unaddressed<br>Calls.....   | 132 | 6.11.4 Scan.....  | 137 |
| 6.10.9.2 Responding to<br>Unaddressed Calls.....  | 133 | 6.11.4.1 Turning Scan On or Off<br>.....                | 137 |
|   |     | 6.11.4.2 Responding to<br>Transmissions During Scanning | 138 |
|   |     | 6.11.4.3 Deleting Nuisance<br>Channels.....             | 138 |

|  |     |   |     |
|--|-----|---|-----|
| 6.11.4.4 Restoring Nuisance Channels.....  | 139 | 6.11.9.4 Sending Emergency Alarms with Call .....   | 144 |
|  |     | 6.11.9.5 Emergency Alarms with Voice to Follow .....  | 145 |
| 6.11.5 Vote Scan  ..... | 139 | 6.11.9.6 Sending Emergency Alarms with Voice to Follow  .. | 146 |
| 6.11.6 Call Indicator Settings.....  | 139 | 6.11.9.7 Reinitiating Emergency Mode.....   | 146 |
| 6.11.6.1 Escalating Alarm Tone Volume.....   | 139 | 6.11.9.8 Exiting Emergency Mode After Sending the Emergency Alarm.....  | 146 |
| 6.11.7 Call Alert Operation.....   | 139 | 6.11.10 Text Messaging .....  | 147 |
| 6.11.7.1 Making Call Alerts.....   | 140 | 6.11.10.1 Quick Text Messages  .....                       | 147 |
| 6.11.7.2 Responding to Call Alerts .....   | 140 | 6.11.10.1.1 Sending Quick Text Messages  .....             | 147 |
| 6.11.8 Mute Mode.....  | 140 | 6.11.11 Privacy  .....                                     | 148 |
| 6.11.8.1 Turning On Mute Mode  | 140 | 6.11.11.1 Turning Privacy On or Off  .....                 | 148 |
| 6.11.8.2 Exiting Mute Mode.....  | 141 | 6.11.12 Response Inhibit.....   | 149 |
| 6.11.9 Emergency Operation .....   | 141 | 6.11.12.1 Turning Response Inhibit On or Off.....   | 149 |
| 6.11.9.1 Receiving Emergency Alarms.....   | 142 |   |     |
| 6.11.9.2 Exiting Emergency Mode After Receiving the Emergency Alarm.....                                 | 143 |   |     |
| 6.11.9.3 Sending Emergency Alarms .....  | 143 |   |     |

|           |  |       |     |
|-----------|--|-------|-----|
|           |                           |       |     |
| 6.11.13   | Multi-Site Control   | ..... | 149 |
| 6.11.13.1 | Enabling Manual Site Search  | ..... | 150 |
| 6.11.13.2 | Site Lock On/Off   | ..... | 150 |
| 6.11.14   | Lone Worker  | ..... | 150 |
| 6.11.15   | Bluetooth®   | ..... | 151 |
| 6.11.15.1 | Connecting to Bluetooth Devices  | ..... | 152 |
| 6.11.15.2 | Disconnecting from Bluetooth Devices   | ..... | 152 |
| 6.11.15.3 | Switching Audio Route between Internal Radio Speaker and Bluetooth Device                                  | ..    | 152 |
| 6.11.16   | Indoor Location  | ..... | 153 |
| 6.11.16.1 | Turning Indoor Location On or Off  | ..... | 153 |
| 6.11.17   | Auto-Range Transponder   |       |     |
|           |                           |       |     |
|           | System   | ..... | 153 |
| 6.11.18   | Over-the-Air Programming  |       | 154 |
| 6.11.19   | Transmit Inhibit   | ..... | 154 |
| 6.11.19.1 | Enabling Transmit Inhibit  | ..... | 154 |
| 6.11.19.2 | Disabling Transmit Inhibit   | ..... | 155 |
| 6.11.20   | Password Lock  | ..... | 155 |
| 6.11.20.1 | Accessing the Radio by Using Password  | ..... | 155 |
| 6.11.20.2 | Unlocking Radios in Locked State   | ..... | 156 |
| 6.11.21   | Wi-Fi Operation  | ..... | 156 |
| 6.11.21.1 | Turning Wi-Fi On or Off  | ..... | 157 |
| 6.11.21.2 | Connecting to a Network Access Point   | ..... | 157 |
| 6.12      | Utilities  | ..... | 158 |
| 6.12.1    | Squelch Levels   | ..... | 158 |
| 6.12.1.1  | Setting Squelch Levels   | ..... | 158 |
| 6.12.2    | Power Levels   | ..... | 158 |
| 6.12.2.1  | Setting Power Levels   | ...   | 158 |
| 6.12.3    | Turning Radio Tones/Alerts On or Off   | ..... | 159 |
| 6.12.4    | Turning Horns/Lights On or Off   |       | 159 |

|   |     |   |     |
|---|-----|---|-----|
| 6.12.5 Turning Public Address System On or Off.....                     | 160 | Limited Warranty.....                               | 166 |
| 6.12.6 Turning External Public Address System On or Off.....            | 160 | MOTOROLA SOLUTIONS COMMUNICATION PRODUCTS.....      | 166 |
| 6.12.7 Voice Operating Transmission... 160                              |     | I. WHAT THIS WARRANTY COVERS AND FOR HOW LONG:..... | 166 |
| 6.12.7.1 Turning Voice Operating Transmission On or Off.....            | 161 | II. GENERAL PROVISIONS.....                         | 167 |
| 6.12.8 Turning Voice Announcement On or Off .....                       | 161 | III. STATE LAW RIGHTS:.....                         | 167 |
| 6.12.9 Turning Option Board On or Off. 162                              |     | IV. HOW TO GET WARRANTY SERVICE.....                | 167 |
| 6.12.10 Text-to-Speech.....   | 162 | V. WHAT THIS WARRANTY DOES NOT COVER.....           | 167 |
| 6.12.10.1 Setting Text-to-Speech.....                                   | 162 | VI. PATENT AND SOFTWARE PROVISIONS                  | 168 |
| 6.12.11 Turning Intelligent Audio On or Off.....                        | 162 | VII. GOVERNING LAW.....                             | 169 |
| 6.12.12 Turning the Acoustic Feedback Suppressor Feature On or Off..... | 163 | VIII. For Australia Only.....                       | 169 |
| 6.12.13 Turning Trill Enhancement On or Off.....                        | 163 |   |     |
| 6.12.14 Turning Global Navigation Satellite System On or Off.....       | 163 |   |     |
| Part IV: Authorized Accessories List.....                               | 165 |   |     |

## Important Safety Information

---

### RF Energy Exposure and Product Safety Guide for Mobile Two-Way Radios



**CAUTION:**

**This radio is restricted to Occupational use only.**

Before using the radio, read the RF Energy Exposure and Product Safety Guide for Mobile Two-Way Radios which contains important operating instructions for safe usage and RF energy awareness and control for Compliance with applicable standards and Regulations.

## Software Version

---

All the features described in the following sections are supported by the software version **R02.21.01.0000** or later.

Contact your dealer or administrator for more information.

## Copyrights

---

The Motorola Solutions products described in this document may include copyrighted Motorola Solutions computer programs. Laws in the United States and other countries preserve for Motorola Solutions certain exclusive rights for copyrighted computer programs. Accordingly, any copyrighted Motorola Solutions computer programs contained in the Motorola Solutions products described in this document may not be copied or reproduced in any manner without the express written permission of Motorola Solutions.

© 2021 Motorola Solutions, Inc. All Rights Reserved

No part of this document may be reproduced, transmitted, stored in a retrieval system, or translated into any language or computer language, in any form or by any means, without the prior written permission of Motorola Solutions, Inc.

Furthermore, the purchase of Motorola Solutions products shall not be deemed to grant either directly or by implication, estoppel or otherwise, any license under the copyrights, patents or patent applications of Motorola Solutions, except for the normal non-exclusive, royalty-free license to use that arises by operation of law in the sale of a product.

## Disclaimer

Please note that certain features, facilities, and capabilities described in this document may not be applicable to or licensed for use on a specific system, or may be dependent upon the characteristics of a specific mobile subscriber unit or configuration of certain parameters. Please refer to your Motorola Solutions contact for further information.

## Trademarks

MOTOROLA, MOTO, MOTOROLA SOLUTIONS, and the Stylized M Logo are trademarks or registered trademarks of Motorola Trademark Holdings, LLC and are used under license. All other trademarks are the property of their respective owners.

## Open Source Content

This product contains Open Source software used under license. Refer to the product installation media for full Open Source Legal Notices and Attribution content.

## European Union (EU) Waste of Electrical and Electronic Equipment (WEEE) directive



■ The European Union's WEEE directive requires that products sold into EU countries must have the crossed out trash bin label on the product (or the package in some cases).

As defined by the WEEE directive, this cross-out trash bin label means that customers and end-users in EU countries should not dispose of electronic and electrical equipment or accessories in household waste.

Customers or end-users in EU countries should contact their local equipment supplier representative or service centre for information about the waste collection system in their country.

## Computer Software Copyrights

---

The Motorola Solutions products described in this manual may include copyrighted Motorola Solutions computer programs stored in semiconductor memories or other media. Laws in the United States and other countries preserve for Motorola Solutions certain exclusive rights for copyrighted computer programs including, but not limited to, the exclusive right to copy or reproduce in any form the copyrighted computer program. Accordingly, any copyrighted Motorola Solutions computer programs contained in the Motorola Solutions products described in this manual may not be copied, reproduced, modified, reverse-engineered, or distributed in any manner without the express written permission of Motorola Solutions. Furthermore, the purchase of Motorola Solutions products shall not be deemed to grant either directly or by implication, estoppel, or otherwise, any license under the copyrights, patents or patent applications of Motorola Solutions, except for the normal non-exclusive license to use that arises by operation of law in the sale of a product.

The AMBE+2™ voice coding Technology embodied in this product is protected by intellectual property rights including

patent rights, copyrights and trade secrets of Digital Voice Systems, Inc.

This voice coding Technology is licensed solely for use within this Communications Equipment. The user of this Technology is explicitly prohibited from attempting to decompile, reverse engineer, or disassemble the Object Code, or in any other way convert the Object Code into a human-readable form.

U.S. Pat. Nos. #5,870,405, #5,826,222, #5,754,974, #5,701,390, #5,715,365, #5,649,050, #5,630,011, #5,581,656, #5,517,511, #5,491,772, #5,247,579, #5,226,084 and #5,195,166.

# Radio Care

This section describes the basic handling precaution of the radio.

**Table 1: IP Specification**

| IP Specification | Description   |
|------------------|---|
| IP67             | Allows your radio to withstand adverse field conditions such as being submersed in water. |



**CAUTION:**

Do not disassemble your radio. This could damage radio seals and result in leak paths into the radio. Radio maintenance should only be done in service depot that is equipped to test and replace the seal on the radio.

- If your radio has been submersed in water, shake your radio well to remove any water that may be trapped inside the speaker grille and microphone port. Trapped water could cause decreased audio performance.
- If your radio's battery contact area has been exposed to water, clean and dry battery contacts on both your radio

and the battery before attaching the battery to radio. The residual water could short-circuit the radio.

- If your radio has been submersed in a corrosive substance (for example, saltwater), rinse radio and battery in fresh water then dry radio and battery.
- To clean the exterior surfaces of your radio, use a diluted solution of mild dishwashing detergent and fresh water (for example, one teaspoon of detergent to one gallon of water).
- Never poke the vent (hole) located on the radio chassis below the battery contact. This vent allows for pressure equalization in the radio. Doing so may create a leak path into radio and your radio's submersibility may be lost.
- Never obstruct or cover the vent, even with a label.
- Ensure that no oily substances come in contact with the vent.
- Your radio with antenna attached properly is designed to be submersible to a maximum depth of 1 m (3.28 ft) and a maximum submersion time of 30 minutes. Exceeding either maximum limit or use without antenna may result in damage to your radio.

- When cleaning your radio, do not use a high pressure jet spray on radio as this will exceed the 1 m depth pressure and may cause water to leak into your radio.

## Getting Started

---

Getting Started provides instructions to prepare your radio for use.

### 1.1

## Turning the Radio On

Press the **On/Off** button.

---

If successful, your radio shows the following indications:

- A tone sounds.



**NOTICE:**

If the Tones/Alerts function is disabled, there is no tone upon powering up.

- The green LED lights up.
- The display screen lights up.

If your radio does not power up, check your battery. Make sure that the battery is charged and properly attached. Contact your dealer if your radio still does not power up.

### 1.2

## Turning the Radio Off

Press and hold the **On/Off** button.

The radio may take up to seven seconds to completely turn off.

---

### 1.3

## Adjusting the Volume

To adjust the volume of your radio, perform one of the following actions:

- To increase the volume, turn the **On/Off/Volume Control** knob clockwise.
- To decrease the volume, turn the **On/Off/Volume Control** knob counterclockwise.



**NOTICE:**

Your radio can be programmed to have a minimum volume offset where the volume level cannot be lowered past the programmed minimum volume.

---

# Radio Controls

This chapter explains the buttons and functions to control the radio.

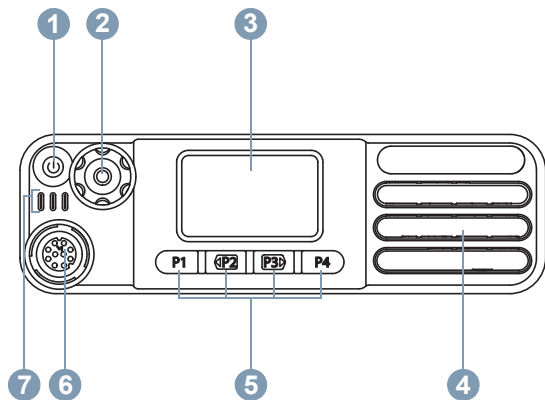

- 1 On/Off/Information Button
- 2 Volume/Channel Knob
- 3 Display
- 4 Speaker
- 5 Front Programmable Buttons
- 6 Accessory Connector

## 7 LED Indicators

### 2.1

## Volume/Channel Knob

The **Volume/Channel Knob** can be programmed for dual volume and channel control, or for volume control only.

To adjust the volume, see [Adjusting the Volume on page 21](#).

To change the channels, press and hold the **Volume/Channel Knob** until the display blinks to enter the channel selection state. Turn the **Volume/Channel Knob** to select the channel. The display continues blinking until you exit the channel selection state. Do one of the following:

- Press the **Volume/Channel Knob**.
- Wait for the menu timer to expire.

# WAVE

---

Wide Area Voice Environment (WAVE™) provides a new method of making calls between two or more radios.

WAVE allows you to communicate across different networks and devices using Wi-Fi. WAVE calls are made when the radio is connected to an IP network through Wi-Fi.

Your radio supports different system configurations:

- WAVE OnCloud/OnPremise

The method to initiate a WAVE Call is different for each system type. Refer to the appropriate section depending on the system configuration of your radio.



**NOTICE:**

This feature is applicable to specific models only.

## 3.1

### WAVE OnCloud/OnPremise

#### 3.1.1

## Switching from Radio Mode to WAVE Mode

Press the programmed **WAVE** button.

---

The yellow LED double blinks.

The display shows a blinking –.



**NOTICE:**

Your radio automatically enables Wi-Fi after you switch to WAVE mode.

If successful:

- The blinking yellow LED turns off.
- The display shows the <Channel Index>.

If unsuccessful:

- A negative tone sounds.
- The red LED blinks.

- The display shows --.



## **NOTICE:**

Synchronization occurs when new settings are updated to your radio. When you enter the WAVE mode, your radio displays `Syncing...`. When the synchronization completes, your radio returns to the home screen.

### 3.1.2

## Making WAVE Group Calls

- 1** Use the channel selector knob or buttons to select a WAVE talkgroup.

---
- 2** To call, press the **PTT** button.

---

If the call is unsuccessful:

- A negative indicator tone sounds.

### 3.1.3

## Receiving and Responding to WAVE Group Calls

When you receive a WAVE group call:

- A tone sounds.
- Your radio unmutes and the incoming call sounds through the speaker.

**1** To call, press the **PTT** button.

---

**2** To listen, release the **PTT** button.

---

### 3.1.4

## Receiving and Responding to WAVE Private Calls

When you receive a WAVE private call:

- A tone sounds.
- Your radio unmutes and the incoming call sounds through the speaker.

**1** To call, press the **PTT** button.

---

**2** To listen, release the **PTT** button.

---

## 3.1.5

## Switching from WAVE Mode to Radio Mode

Press the programmed **Radio Mode** button.

---

The yellow LED double blinks.

The display shows a blinking –.

When successful:

- The blinking yellow LED turns off.
- The display shows <Channel Index>.

## Capacity Max

---

Capacity Max is MOTOTRBO control channel based trunked radio system.

MOTOTRBO digital radio products are marketed by Motorola Solutions primarily to business and industrial users. MOTOTRBO uses the European Telecommunications Standards Institute (ETSI) Digital Mobile Radio (DMR) standard, that is, two-slot Time Division Multiple Access (TDMA), to pack simultaneous voice or data in a 12.5 kHz channel (6.25 kHz equivalent).

### 4.1

## Push-To-Talk (PTT) Button

---

The **PTT** button serves two basic purposes.

- While a call is in progress, the **PTT** button allows the radio to transmit to other radios in the call. The microphone is activated when the **PTT** button is pressed.
- While a call is not in progress, the **PTT** button is used to make a new call.

Press and hold the **PTT** button to talk. Release the **PTT** button to listen.

If the Talk Permit Tone or the **PTT** Sidetone is enabled, wait until the short alert tone ends before talking.

If the Channel Free Indication feature is enabled on your radio (programmed by your dealer), you will hear a short alert tone the moment the target radio (the radio that is receiving your call) releases the **PTT** button, indicating the channel is free for you to respond.

You hear a continuous Talk Prohibit Tone if your call is interrupted, for example when the radio receives an Emergency call. You should release the **PTT** button.

### 4.2

## Programmable Buttons

---

Depending on the duration of a button press, your dealer can program the programmable buttons as shortcuts to radio functions.

### Short press

Pressing and releasing rapidly.

**Long press**

Pressing and holding for the programmed duration.

**NOTICE:**

See [Emergency Operation on page 141](#) for more information on the programmed duration of the **Emergency** button.

## 4.3

## Assignable Radio Functions

---

The following radio functions can be assigned to the programmable buttons by your dealer or system administrator.

**Bluetooth® Audio Switch**

Toggles audio routing between internal radio speaker and external Bluetooth-enabled accessory.

**Bluetooth Connect**

Initiates a Bluetooth find-and-connect operation.

**Bluetooth Disconnect**

Terminates all existing Bluetooth connections between your radio and any Bluetooth-enabled devices.

**Bluetooth Discoverable**

Enables your radio to enter Bluetooth Discoverable Mode.

**Cancel**

Allows users to end selected calls.

**Emergency**

Depending on the programming, initiates or cancels an emergency.

**Ext Public Address (PA)**

Toggles audio routing between the connected PA loudspeaker amplifier and the internal PA system of the radio.

**Manual Site Roam**

Starts the manual site search.

**Mic AGC**

Toggles the internal microphone automatic gain control (AGC) on or off.

**One Touch Access**

Directly initiates a predefined Broadcast, Private, Phone or Group Call, a Call Alert, or a Quick Text message.

**Option Board Feature**

Toggles option board feature(s) on or off for option board-enabled channels.

**Phone Exit**

Ends a Phone Call.

### **Privacy**

Toggles privacy on or off.

### **Public Address (PA)**

Toggles the internal PA system of the radio on or off.

### **Reset Home Channel**

Sets a new home channel.

### **Silence Home Channel Reminder**

Mutes the Home Channel Reminder.

### **Site Info**

Plays site announcement voice messages for the current site when Voice Announcement is enabled.

### **Site Lock**

When toggled on, the radio searches the current site only. When toggled off, the radio searches other sites in addition to the current site.

### **Status**

Selects the status list menu.

### **Telemetry Control**

Controls the Output Pin on a local or remote radio.

### **Toggle Call Priority Level**

Enables your radio to enter Call Priority Level High/Normal.

### **Trill Enhancement**

Toggles trill enhancement on or off.

### **Voice Announcement On/Off**

Toggles voice announcement on or off.

### **Voice Announcement for Channel**

Plays zone and channel announcement voice messages for the current channel. This function is unavailable when Voice Announcement is disabled.

### **Wi-Fi**

Toggles Wi-Fi on or off.

### **Zone Toggle**

Allows radio user to toggle between Zone 1 and Zone 2.

## 4.4

# Assignable Settings or Utility Functions

---

The following radio settings or utility functions can be assigned to the programmable buttons.

### **Tones/Alerts**

Toggles all tones and alerts on or off.

**Channel Up/Down**

Depending on the programming, changes channel to previous or next channel.

**Power Level**

Toggles transmit power level between high and low.

## 4.5

## Status Indicators

---

This chapter explains the status indicators and audio tones used in the radio.

## 4.5.1

### LED Indicator

The LED indicator shows the operational status of your radio.

**Blinking Red**

Radio has failed the self-test upon powering up.

Radio is receiving an emergency transmission.

Radio is transmitting in low battery state.

Radio has moved out of range if Auto-Range Transponder System is configured.

Mute Mode is enabled.

**Solid Green**

Radio is powering up.

Radio is transmitting.

Radio is sending a Call Alert or an emergency transmission.

**Blinking Green**

Radio is powering up.

Radio is receiving a call or data.

Radio is retrieving Over-the-Air Programming transmissions over the air.

Radio is detecting activity over the air.

**NOTICE:**

This activity may or may not affect the programmed channel of the radio due to the nature of the digital protocol.

**Double Blinking Green**

Radio is receiving a privacy-enabled call or data.

**Solid Yellow**

Radio is in Bluetooth Discoverable Mode.

**Blinking Yellow**

Radio has yet to respond to a Call Alert.

### Double Blinking Yellow

Radio has Auto Roaming enabled.

Radio is actively searching for a new site.

Radio has yet to respond to a Group Call Alert.

Radio is locked.

#### 4.5.2

## Tones

The following are the tones that sound through on the radio speaker.



High Pitched Tone



Low Pitched Tone

#### 4.5.2.1

## Audio Tones

Audio tones provide you with audible indications of the status, or response to data received on the radio.



### Continuous Tone

A monotone sound. Sounds continuously until termination.



### Periodic Tone

Sounds periodically depending on the duration set by the radio. Tone starts, stops, and repeats itself.



### Repetitive Tone

A single tone that repeats itself until it is terminated by the user.



### Momentary Tone

Sounds once for a short duration set by the radio.

#### 4.5.2.2

## Indicator Tones

Indicator tones provide you with audible indications of the status after an action to perform a task is taken.



Positive Indicator Tone



Negative Indicator Tone

## 4.6

# Registration

---

There are a number of registration-related messages that you may receive.

## Registering

Typically, registration is sent to the system during power-up, Talkgroup change, or during site roaming. If a radio fails registration on a site, the radio automatically attempts to roam to another site. The radio temporarily removes the site where registration was attempted from the roaming list.

The indication means that the radio is busy searching for a site to roam, or that the radio has found a site successfully but is waiting for a response to the registration messages from the radio.

When a radio is registering, a tone sounds and the yellow LED double flashes to indicate a site search.

If the indications persist, the user should change locations or if allowed, manually roam to another site.

## Out of Range

A radio is deemed to be out of range when the radio is unable to detect a signal from the system or from the current site. Typically, this indication means that the radio is outside of the geographic outbound radio frequency (RF) coverage range.

When a radio is out of range, a repetitive tone sounds and the red LED flashes.

Contact your dealer or system administrator if the radio still receives out of range indications while being in an area with good RF coverage.

## Talkgroup Affiliation Failed

A radio tries to affiliate to the Talkgroup specified in the channels or Unified Knob Position (UKP) during registration.

A radio that is in affiliation fail state is unable to make or receive calls from the Talkgroup that the radio is trying to affiliate to.

Contact your dealer or system administrator if the radio receives affiliation failure indications.

## Register Denied

Registration denied indicators are received when the registration with the system is not accepted.

The radio does not indicate to the radio user the specific reason the registration was denied. Normally, a registration is denied when the system operator has disabled the access of the radio to the system.

When a radio is denied registration, the yellow LED double flashes to indicate a site search.

### 4.7

## Zone and Channel Selections

---

This chapter explains the operations to select a zone or channel on your radio.

The radio can be programmed with a maximum of 250 Capacity Max Zones with a maximum of 160 Channels per zone. Each Capacity Max zone contains a maximum of 16 assignable positions. Each Capacity Max zone contains a maximum of 16 assignable positions.

### 4.7.1

## Selecting Zones

Follow the procedure to select the required zone on your radio.

Press the programmed **Zone Toggle** button.

One of the following tone sounds:

### **Positive Indicator Tone**

Radio is in Zone 2.

### **Negative Indicator Tone**

Radio is in Zone 1.



### **NOTICE:**

For all Non-keypad radio, you are recommended to enable Voice Announcement feature for selecting zone. The Voice Announcement feature can only be enabled through CPS.

---

### 4.7.2

## Selecting a Call Type

Use the Channel Selector Knob to select a call type. This can be a Group Call, Broadcast Call, All Call, or Private Call, depending on how your radio is programmed. If you

change the Channel Selector Knob to a different position (that has a call type assigned to it), this causes the radio to re-register with the Capacity Max System. The radio registers with the Talkgroup ID that has been programmed for the new Channel Selector Knob position call type.

Your radio does not operate when selected to an unprogrammed channel, use the Channel Selector Knob to select a programmed channel instead.

Once the required zone is set (if you have multiple zones in your radio), turn the programmed Channel Selector Knob to select the call type.

---

#### 4.7.3

### Selecting a Site

A site provides coverage for a specific area. In a multi-site network, the Capacity Max radio will automatically search for a new site when the signal level from the current site drops to an unacceptable level.

The Capacity Max system can support up to 250 sites.

#### 4.7.4

## Roam Request

A Roam Request tells the radio to search for a different site, even if the signal from the current site is acceptable.

If there are no sites available:

- The radio continues to search through the list of sites.
- The radio will return to the previous site, if the previous site is still available.



#### NOTICE:

This is programmed by your dealer.

Press the programmed **Manual Site Roam** button.

You hear a tone, indicating the radio has switched to a new site.

---

#### 4.7.5

### Site Lock On/Off

When toggled on, the radio searches the current site only. When toggled off, the radio searches other sites in addition to the current site.

Press the programmed **Site Lock** button.

If the **Site Lock** function is toggled on:

- You hear a positive indicator tone, indicating the radio has locked to the current site.

If the **Site Lock** function is toggled off:

- You hear a negative indicator tone, indicating the radio is unlocked.
- 

#### 4.7.6

### Site Restriction

In Capacity Max system, your radio administrator has the ability to decide which network sites your radio is and is not allowed to use.

The radio does not have to be reprogrammed to change the list of allowed and disallowed sites. If your radio

attempts to register at a disallowed site, your radio receives indication that the site is denied. The radio then searches for a different network site.

When experiencing site restrictions, the yellow LED double flashes to indicate a site search.

#### 4.7.7

### Site Trunking

Site Trunking is only available with Capacity Max system. A site must be able to communicate with the Trunk Controller to be considered as System Trunking.

If the site cannot communicate with the Trunk Controller in the system, a radio enters Site Trunking mode. While in Site Trunking, the radio provides a periodic audible and visual indication to the user to inform the user of their limited functionality.

When a radio is in Site Trunking, a repetitive tone sounds.

The radios in Site Trunking are still able to make group and individual voice calls as well as send text messages to other radios within the same site. Voice consoles, logging recorders, phone gateways, and data applications cannot communicate to the radios at the site.

Once in Site Trunking, a radio that is involved in calls across multiple sites will only be able to communicate with other radios within the same site. Communication to and from other sites would be lost.



**NOTICE:**

If there are multiple sites that cover the current location of the radio and one of the sites enters Site Trunking, the radio roams to another site if within coverage.

4.8

## Calls

---

This chapter explains the operations to receive, respond to, make, and stop calls.

You can select a subscriber alias or ID, or group alias or ID after you have selected a channel by using one of these features:

**Programmed One Touch Access Button**

This method is used for Group, Private, and Phone Calls only.

You can only have one ID assigned to a **One Touch Access** button with a short or long programmable button press.

**Programmable Button**

This method is used for Phone Calls only.

**Volume/Channel Selector Knob**

This method manually selects a subscriber alias or ID, or group alias or ID.

4.8.1

## Group Calls

Your radio must be configured as part of a group to receive a call from or make a call to the group of users.

4.8.1.1

### Making Group Calls

To make a call to a group of users, your radio must be configured as part of that group.

- 1 Do one of the following:
    - Select a channel with the active group alias or ID. See [Selecting a Call Type on page 32](#).
    - Press the programmed **One Touch Access** button.
-

- 2 Press the **PTT** button to make the call.  
The green LED lights up.
- 

- 3 Do one of the following:
    - Wait for the Talk Permit Tone to end and speak clearly into the microphone if enabled.
    - Wait for the **PTT** Sidetone to end and speak clearly into the microphone if enabled.
- 

- 4 Release the **PTT** button to listen.  
The green LED lights up when the target radio responds.
- 

- 5 If the Channel Free Indication feature is enabled, you hear a short alert tone the moment the transmitting radio releases the **PTT** button, indicating the channel is free for you to respond. Press the **PTT** button to respond to the call.

The call ends when there is no voice activity for a predetermined period.

The call initiator can press the programmed **Cancel** button to end a Group Call.

---

#### 4.8.1.2

### Responding to Group Calls

When you receive a Group Call:

- The green LED blinks.
- Your radio unmutes and the incoming call sounds through the speaker.

- 1 Do one of the following:

- If the Channel Free Indication feature is enabled, you hear a short alert tone the moment the transmitting radio releases the **PTT** button, indicating the channel is free for you to respond. Press the **PTT** button to respond to the call.
- If the Voice Interrupt feature is enabled, press the **PTT** button to interrupt the audio from the transmitting radio and free the channel for you to respond.

The green LED lights up.

---

- 2 Do one of the following:

- Wait for the Talk Permit Tone to end and speak clearly into the microphone if enabled.

- Wait for the **PTT** Sidetone to end and speak clearly into the microphone if enabled.
- 

**3** Release the **PTT** button to listen.

The call ends when there is no voice activity for a predetermined period.

---

#### 4.8.2

## Broadcast Call

A Broadcast Call is a one-way voice call from any user to an entire talkgroup.

The Broadcast Call feature allows only the call initiating user to transmit to the talkgroup, while the recipients of the call cannot respond.

The broadcast initiator can also end the broadcast call. To receive a call from a group of users, or to call a group of users, the radio must be configured as part of a group.

#### 4.8.2.1

### Making Broadcast Calls

**1** Do one of the following:

- Select a channel with the active group alias or ID. See [Selecting a Call Type on page 32](#).
  - Press the programmed **One Touch Access** button.
- 

**2** Press the **PTT** button to make the call.

The green LED lights up.

---

**3** Do one of the following:

- Wait for the Talk Permit Tone to end and speak clearly into the microphone if enabled.
- Wait for the **PTT** Sidetone to end and speak clearly into the microphone if enabled.

The call initiator can press the programmed **Cancel** button to end the Broadcast Call.

---

#### 4.8.2.2

### Receiving Broadcast Calls

Follow the procedure to receive a Broadcast Call on your radio.

When you receive a Broadcast Call:

- The green LED blinks.

- Your radio unmutes and the incoming call sounds through the speaker.

**NOTICE:**

Recipient users are not allowed to Talkback during a Broadcast Call. The Talkback Prohibit Tone plays momentarily if the **PTT** button is pressed during a Broadcast Call.

### 4.8.3

## Private Call

A Private Call is a call from an individual radio to another individual radio.

There are two ways to set up a Private Call.

- The first call type is called Off Air Call Set-Up (OACSU). OACSU sets up the call after performing a radio presence check and completes the call automatically.
- The second type is called Full Off Air Call Set-Up (FOACSU). FOACSU also sets up the call after performing a radio presence check. However, FOACSU calls require user acknowledgment to complete the call and allows the user to either Accept or Decline the call.

The type of call is configured by the system administrator.

**NOTICE:**

Both the call initiator and recipient are able to terminate an on-going Private Call by pressing the programmed **Cancel** button.

### 4.8.3.1

## Making Private Calls

Your radio must be programmed for you to initiate a Private Call. If this feature is not enabled, you hear a negative indicator tone when you initiate the call. If the target radio is not available, a short tone sounds.

- 1 Do one of the following:
  - Select a channel with the active subscriber alias or ID. See [Selecting a Call Type on page 32](#).
  - Press the programmed **One Touch Access** button.

---
- 2 Press the **PTT** button to make the call.  
The green LED lights up.

---
- 3 Wait for the Talk Permit Tone to end and speak clearly into the microphone if enabled.

---

- 4 Release the **PTT** button to listen.

The green LED lights up when the target radio responds.

---

- 5 The call ends when there is no voice activity for a predetermined period. You will hear a short tone.

Both the call initiator and recipient are able to terminate an on-going Private Call by pressing the programmed **Cancel** button.

---

#### 4.8.3.2

### Making a Private Call with a One Touch Call Button

The One Touch Call feature allows you to easily make a Private Call to a pre-defined Private Call alias or ID. This feature can be assigned to a short or long programmable button press.

You can only have one alias or ID assigned to a One Touch Call button. Your radio can have multiple One Touch Call buttons programmed.

- 1 Press the programmed **One Touch Call** button to make a Private Call to the pre-defined Private Call alias or ID.
- 

- 2 Press the **PTT** button to make the call.  
The LED lights up solid green.
- 

- 3 Wait for the Talk Permit Tone to finish (if enabled) and speak clearly into the microphone.
- 

- 4 Release the **PTT** button to listen.

When the target radio responds, the LED blinks green.

If there is no voice activity for a predetermined period of time, the call ends.

Both the call initiator and recipient are able to terminate an on-going Private Call by pressing the programmed **Cancel** button.

---

#### 4.8.3.3

### Receiving Private Calls

When you receive Private Calls configured as Off Air Call Set-Up (OACSU):

- The green LED blinks.
- Your radio unmutes and the incoming call sounds through the speaker.



**NOTICE:**

Depending on how your radio is configured, either OACSU or Full Off Air Call Set-Up (FOACSU), responding to Private Calls may or may not require user acknowledgment.

For the OACSU configuration, your radio unmutes and the call connects automatically.

#### 4.8.3.4

### Accepting Private Calls

When you receive Private Calls configured as Full Off Air Call Set-Up (FOACSU):

- The green LED blinks.
  - 1 To accept a Private Call, perform the following action:
    - Press the **PTT** button on any entry.  
The green LED lights up.

---

- 2 Wait for the Talk Permit Tone to end and speak clearly into the microphone if enabled.

---

- 3 Release the **PTT** button to listen.

The call ends when there is no voice activity for a predetermined period. A tone sounds.



**NOTICE:**

Both the call initiator and recipient are able to terminate an on-going Private Call by pressing the programmed **Cancel** button.

---

#### 4.8.3.5

### Declining Private Calls

When you receive Private Calls configured as Full Off Air Call Set-Up (FOACSU):

- The green LED blinks.

To decline a Private Call, perform the following action:

- Press the programmed **Cancel** button.
- 

#### 4.8.4

## All Calls

An All Call is a call from an individual radio to every radio on the site or every radio at a group of sites, depending on system configuration.

An All Call is used to make important announcements, requiring full attention from the user. The users on the system cannot respond to an All Call.

Capacity Max supports Site All Call and Multi-site All Call. The system administrator may configure one or both of these in your radio.



### NOTICE:

Subscribers can support System-Wide All Calls but Motorola Solutions infrastructure does not support System-Wide All Calls.

#### 4.8.4.1

## Making All Calls

Your radio must be programmed for you to make an All Call.

- 1 Select a channel with the active All Call group alias or ID. See [Selecting a Call Type on page 32](#).
- 

- 2 Press the **PTT** button to make the call.

The green LED lights up.

---

- 3 Do one of the following:

- Wait for the Talk Permit Tone to end and speak clearly into the microphone if enabled.
- Wait for the **PTT** Sidetone to end and speak clearly into the microphone if enabled.

Users on the channel cannot respond to an All Call. The call initiator can press the programmed **Cancel** button to end the All Call.

---

#### 4.8.4.2

## Receiving All Calls

When you receive an All Call, the following occur:

- A tone sounds.
- The green LED blinks.
- Your radio unmutes and the incoming call sounds through the speaker.

If the Channel Free Indication feature is enabled, you hear a short alert tone when the transmitting radio releases the **PTT** button, indicating the channel is free for you to use. You cannot respond to an All Call.



### **NOTICE:**

The radio stops receiving the All Call if you switch to a different channel while receiving the call. You are not able to continue with any menu navigation or editing until the call ends during an All Call.

#### 4.8.5

## Phone Calls

A Phone Call is a call in between an individual radio or a group of radios and a telephone.

Depending on how the radio is configured, the following features may or may not be made available:

- Access code
- Dual Tone Multi Frequency (DTMF) tone

- De-access code
- Displaying of caller alias or ID on receiving a phone call
- Ability to reject or accept a phone call

The Phone Call capability can be enabled by assigning and setting up phone numbers on the system. Check with your system administrator to determine how your radio has been programmed.

#### 4.8.5.1

## Making Phone Calls

Follow the procedure to make Phone Calls on your radio.

When you attempt to make or end a Phone Call without the access and deaccess codes preconfigured, the attempt fails and a negative indicator tone sounds.

- 1 Press the programmed **One Touch Access** button to the predefined alias or ID.

If the entry for the **One Touch Access** button is empty, a negative indicator tone sounds.

If successful:

- The DMTF Tone sounds.

- You hear the call waiting tone of the telephone user.

If unsuccessful:

- A negative indicator tone sounds.
- The phone call fails. Repeat this step.

---

**2** Press the **PTT** button to respond to the call.

---

**3** Release the **PTT** button to listen.

---

**4** Press the programmed **Phone Exit** button to end the call.

If end-call-setup is successful:

- A tone sounds.

If end-call-setup is unsuccessful:

- A negative indicator tone sounds.
  - Repeat this step, or wait for the telephone user to end the call.
- 

## Making Phone Calls with the Programmable Button

Follow the procedure to make Phone Calls with the programmable button.

**1** Press the programmed **Phone** button to enter into the Phone Entry list.

---

**2** Press or to the required alias or ID. Press to select.

The green LED lights up. The display shows **Phone Call** icon, subscriber alias or ID, and call status.

If the call-setup is successful:

- The DTMF tone sounds.
- You hear the call waiting tone of the telephone user.
- The display shows **Phone Call** icon, subscriber alias or ID, `Phone Call`, and call status.

If call-setup is unsuccessful:

- A tone sounds.
- The display shows `Phone Call Failed`.

- Your radio returns to the Access Code input screen. If the access code was preconfigured in the Contacts list, the radio returns to the screen you were on prior to initiating the call.

---

**3** Press the **PTT** button to talk. Release the **PTT** button to listen.

---

**4** Press to end the call.

If the end-call-setup is successful, a tone sounds and the display shows `Call Ended`.

If the end-call-setup is unsuccessful, your radio returns to the Phone Call screen.

When you press **PTT** button while in the Phone Contacts screen, a tone sounds and the display shows `Press OK to Place Call`.

When the telephone user ends the call, a tone sounds and the display shows `Phone Call Ended`.



### **NOTICE:**

During channel access, press to dismiss the call attempt and a tone sounds.

During the call, when you press **One Touch Access** button with the deaccess code preconfigured or enter the deaccess code as the input for extra digits, your radio attempts to end the call.

---

#### 4.8.5.3

### **Responding to Phone Calls as All Calls**

When you receive a Phone Call as an All Call, the receiving radio is unable to talkback or respond. The recipient user is also not allowed to end the All Call.

When you receive a Phone Call as an All Call:

- The green LED blinks.

- Your radio unmutes and the incoming call sounds through the speaker.

#### 4.8.5.4

### Responding to Phone Calls as Group Calls

Follow the procedure to respond to Phone Calls as Group Calls on your radio.

When you receive a Phone Call as a Group Call:

- The green LED blinks.
- Your radio unmutes and the incoming call sounds through the speaker.

**1** Press the **PTT** button to respond to the call.

---

**2** Release the **PTT** button to listen.

---

**3** If there is no voice activity for a predetermined period of time, the call ends.



#### **NOTICE:**

Your radio is not able to terminate a phone call as a group call. The telephone user must end the call. The recipient user is only allowed to talk back during the call.

You hear a short tone.

---

#### 4.8.5.5

### Responding to Phone Calls as Private Calls

Follow the procedure to respond to Phone Calls as Private Calls on your radio.

When you receive a Phone Call as a Private Call:

- The green LED blinks.
- Your radio unmutes and the incoming call sounds through the speaker.

**1** Press the **PTT** button to respond to the call.

---

**2** Release the **PTT** button to listen.

---

- 3 If there is no voice activity for a predetermined period of time, the call ends.



**NOTICE:**

Your radio is not able to terminate a phone call as a group call. The telephone user must end the call. The recipient user is only allowed to talk back during the call.

You hear a short tone.

---

4.8.6

## Initiating Transmit Interrupt

An ongoing call is interrupted, when you perform the following actions:

- Press the **Voice PTT** button.
- Press the **Emergency** button.

---

4.8.7

## Call Preemption

Call Preemption allows a radio to stop any in-progress voice transmission and initiate a priority transmission.

With the Call Preemption feature, the system interrupts and preempts ongoing calls in instances where trunked channels are unavailable.

Higher priority calls such as an Emergency Call or an All Call preempt the transmitting radio to accommodate the higher priority call. If no other Radio Frequency (RF) channels are available, an Emergency Call preempts an All Call as well.

4.8.8

## Voice Interrupt

Voice Interrupt allows the user to shut down an in-progress voice transmission.

This feature uses reverse channel signaling to stop the in-progress voice transmission of a radio, if the interrupting radio is configured to Voice Interrupt, and the transmitting radio is configured to be Voice Call Interruptible. The interrupting radio is then allowed to make a voice transmission to the participant in the stopped call.

The Voice Interrupt feature significantly improves the probability of successfully delivering a new transmission to the intended parties when a call is in progress.

Voice Interrupt is accessible to the user only if this feature has been set up in the radio. Check with your dealer or system administrator for more information.

#### 4.8.8.1

### Enabling Voice Interrupt

Follow the procedure to initiate Voice Interrupt on your radio.

Your radio must be programmed to allow you to use this feature. Check with your dealer or system administrator for more information.

- 1 To interrupt the transmission during an on-going call, press the **PTT** button.

The radio sounds a negative indicator tone until the **PTT** button is released.

- 2 Wait for acknowledgment.

If successful:

- A positive indicator tone sounds.

If unsuccessful:

- A negative indicator tone sounds.

- 3 Do one of the following:

- Wait for the Talk Permit Tone to end and speak clearly into the microphone if enabled.
- Wait for the **PTT** Sidetone to end and speak clearly into the microphone if enabled.

## 4.9

### Advanced Features

This chapter explains the operations of the features available in your radio.

Your dealer or system administrator may have customized your radio for your specific needs. Check with your dealer or system administrator for more information.

#### 4.9.1

### Call Queue

When there are no resources available to process a call, Call Queue enables the call request to be placed in the system queue for the next available resources.

You hear a Call Queue Tone after pressing the **PTT** button and radio screen displays `Call In Queue` indicating that

the radio has entered Call Queue State. The **PTT** button may be released once the Call Queue Tone is heard.

If the call setup is successful, the following occur:

- The green LED blinks.
- If enabled, the Talk Permit Tone sounds.
- The radio user has up to 4 seconds to press the **PTT** button to begin voice transmission.

If the call setup is unsuccessful, the following occur:

- If enabled, the Reject Tone sounds.
- The call is terminated and the radio exits the call setup.

### 4.9.2

## Priority Call

Priority Call allows the system to preempt one of the ongoing non-priority calls and initiate the requested high priority call when all channels are busy.

With all channels occupied with high priority calls, the system does not preempt any calls, and places the requesting high-priority call into call queue. If the system fails to place the requesting high-priority call into call queue, it declares failure.

The default settings for Priority Call are preconfigured. Press the programmable button to toggle between normal and high priority level. When you use the following features, the call priority level reverts automatically to the preconfigured setting.

- All voice calls
- DMR III Text Message/Text Message
- Job Ticket
- Remote monitor

The following are the types of Priority Call:

### High Priority

The radio displays `Next Call: High Priority`.

**Call Priority High** icon appears at the top of your radio display.

Voice Announcement sounds `Next Call: High Priority`.

### Normal Priority

The radio displays `Next Call: Normal Priority`.

**Call Priority High** icon disappears.

Voice Announcement sounds `Next Call: Normal Priority`.

## 4.9.3

## Talkgroup Scan

This feature allows your radio to monitor and join calls for groups defined by a Receive Group List.

When scan is enabled, your radio unmutes to any member in its Receive Group List.

When scan is disabled, your radio does not receive transmission from any members of the Receive Group List, except for All Call, Permanent Talkgroup, and the selected Talkgroup.

## 4.9.3.1

### Turning Talkgroup Scan On or Off

Follow the procedure to turn Talkgroup Scan on or off on your radio.

---

Press the programmed **Scan** button.

If scan is enabled:

- The yellow LED blinks.
- A positive indicator tone sounds.

If scan is disabled:

- The LED turns off.
- A negative indicator tone sounds.

## 4.9.4

## Receive Group List

Receive Group List is a feature that allows you to create and assign members on the talkgroup scan list.

This list is created when your radio is programmed and it determines which groups can be scanned. Your radio can support a maximum of 16 members in this list.

If a talkgroup is programmed as Permanent Talkgroup, you are unable to edit the talkgroup from the scan list.



### NOTICE:

Receive Group List is programmed by the system administrator. Check with your dealer or system administrator for more information.

## 4.9.5

## Priority Monitor

The Priority Monitor feature allows the radio to automatically receive transmission from talkgroups with higher priority even when radio is in a talkgroup call.

Radio leaves lower priority talkgroup call for higher priority talkgroup call.



**NOTICE:**

This feature can only be accessed when Talkgroup Scan feature is enabled.

Priority Monitor feature applies only to members in the Receive Group List. There are two Priority Talkgroups: Priority 1 (P1) and Priority 2 (P2). P1 has higher priority than P2. In Capacity Max system, the radio receives transmission according to the priority order below:

- 1 Emergency Call for P1 Talkgroup
- 2 Emergency Call for P2 Talkgroup
- 3 Emergency Call for Non-priority Talkgroups in the Receive Group List
- 4 All Call
- 5 P1 Talkgroup Call
- 6 P2 Talkgroup Call
- 7 Non-priority Talkgroups in the Receive Group List



**NOTICE:**

This feature is programmed by the system administrator. Check with your dealer or system administrator for more information.

### 4.9.6

## Multi-Talkgroup Affiliation

Your radio can be configured for up to seven talkgroups at a site.

Of the 16 talkgroups in the Receive Group List, up to seven talkgroups can be assigned as affiliation talkgroups. The selected talkgroup and the priority talkgroups are automatically affiliated.

### 4.9.7

## Talkback

The Talkback feature allows you to respond to a transmission while scanning.

If your radio scans into a call from the selectable group scan list, and if the **PTT** button is pressed during the scanned call, the operation of the radio depends on whether Talkback was enabled or disabled during radio programming. Check with your dealer or system administrator for more information.

### Talkback Disabled

The radio leaves the scanned call and attempts to transmit on the contact for the currently selected channel position. After the Call Hang Time on the

currently selected contact expires, the radio returns to the home channel and starts the Scan Hang Time Timer. The radio resumes group scan after its Scan Hang Time Timer expires.

### Talkback Enabled

If the **PTT** button is pressed during the Group Hang Time of the scanned call, the radio attempts to transmit to the scanned group.



#### **NOTICE:**

If you scan into a call for a group that is not assigned to a channel position in the currently selected zone and the call ends, switch to the proper zone and then select the channel position of the group to talk back to that group.

### 4.9.8

## Bluetooth®

This feature allows you to use your radio with a Bluetooth-enabled device (accessory) through a Bluetooth connection. Your radio supports both Motorola Solutions and Commercially available Off-The-Shelf (COTS) Bluetooth-enabled devices.

Bluetooth operates within a range of 10 m (32ft) line of sight. This is an unobstructed path between your radio and

your Bluetooth-enabled device. For high degree of reliability, Motorola Solutions recommends to not separate the radio and the accessory.

At the fringe areas of reception, both voice and tone quality start to sound "garbled" or "broken". To correct this problem, position your radio and Bluetooth-enabled device closer to each other (within the 10 m defined range) to re-establish clear audio reception. The Bluetooth function of your radio has maximum power of 2.5 mW (4 dBm) at the 10 m range.

Your radio can support up to three simultaneous Bluetooth connections with Bluetooth-enabled devices of unique types. For example, a headset, a scanner, a sensor device, and a PTT-Only Device (POD).

Refer to the user manual of your respective Bluetooth-enabled device for more details on the full capabilities of your Bluetooth-enabled device.



#### **NOTICE:**

If disabled through CPS, all Bluetooth-related features are disabled and the Bluetooth device database is erased.

#### 4.9.8.1

### Connecting to Bluetooth Devices

Follow the procedure to connect to Bluetooth devices.

Turn on your Bluetooth-enabled device and place it in pairing mode.

Press the programmed **Bluetooth Connect** button.

Your Bluetooth-enabled device may require additional steps to complete the pairing. Refer to the user manual of your Bluetooth-enabled device.

- A tone sounds.
  - The yellow LED blinks.
- 

Wait for acknowledgment.

If successful:

- A positive indicator tone sounds.

If unsuccessful:

- A negative indicator tone sounds.

#### 4.9.8.2

### Disconnecting from Bluetooth Devices

Follow the procedure to disconnect from Bluetooth devices.

Press the programmed **Bluetooth Disconnect** button.

A positive indicator tone sounds when the device has been disconnected.

---

#### 4.9.8.3

### Switching Audio Route between Internal Radio Speaker and Bluetooth Device

Follow the procedure to toggle audio routing between internal radio speaker and external Bluetooth device.

Press the programmed **Bluetooth Audio Switch** button.

---

A tone sounds when the audio route has switched.

#### 4.9.9

## Multi-Site Controls

These features are applicable when your current radio channel is configured to a Capacity Max system.

#### 4.9.9.1

### Enabling Manual Site Search

Press the programmed **Manual Site Roam** button.

- A tone sounds.
- The green LED blinks.

---

If the radio finds a new site, your radio shows the following indications:

- A positive tone sounds.
- The LED extinguishes.

If the radio fails to find a new site, your radio shows the following indications:

- A negative tone sounds.
- The LED extinguishes.

#### 4.9.9.2

### Site Lock On/Off

When toggled on, the radio searches the current site only. When toggled off, the radio searches other sites in addition to the current site.

Press the programmed **Site Lock** button.

If the **Site Lock** function is toggled on:

- You hear a positive indicator tone, indicating the radio has locked to the current site.

If the **Site Lock** function is toggled off:

- You hear a negative indicator tone, indicating the radio is unlocked.

---

#### 4.9.10

### Home Channel Reminder

This feature provides a reminder when the radio is not set to the home channel for a period of time.

If this feature is enabled when your radio is not set to the home channel for a period of time, the following occurs periodically:

- The Home Channel Reminder tone and announcement sound.

You can respond to the reminder by performing one of the following actions:

- Return to the home channel.
- Mute the reminder temporarily by using the programmable button.
- Set a new home channel by using the programmable button.

### 4.9.10.1

## Muting the Home Channel Reminder

When the Home Channel Reminder sounds, you can temporarily mute the reminder.

Press the programmed **Silence Home Channel Reminder** button.

---

### 4.9.10.2

## Setting New Home Channels

When the Home Channel Reminder occurs, you can set a new home channel.

Press the **Reset Home Channel** programmable button to set the current channel as the new Home Channel.

---

### 4.9.11

## Remote Monitor

You can use this feature to remotely monitor any audible activity surrounding the target radio.

Both your radio and the target radio must be programmed to allow you to use this feature.

This feature automatically stops after a programmed duration or when there is any user operation on the target radio.

### 4.9.11.1

## Initiating Remote Monitor

Follow the procedure to initiate Remote Monitor on your radio.

- 1 Press the programmed **Remote Monitor** button.
-

## 2 Wait for acknowledgment.

If successful:

- A positive indicator tone sounds.

If unsuccessful:

- A negative indicator tone sounds.

---

### 4.9.12

## Call Indicator Settings

This feature allows you to configure call or text message ringing tones.

### 4.9.12.1

## Escalating Alarm Tone Volume

The radio can be programmed to continually alert, when a radio call remains unanswered. This is done by automatically increasing the alarm tone volume over time. This feature is known as Escalert.

### 4.9.13

## Call Alert Operation

Call Alert paging enables you to alert a specific radio user to call you back when they are able to do so.

This feature is accessible by using a programmed **One Touch Access** button.

In Capacity Max, the Call Alert feature allows a radio user or a dispatcher to send an alert to another radio user requesting the radio user to call back the initiating radio user when available. Voice communication is not involved in this feature.

The Call Alert Operation can be configured by the dealer or the system administrator to allow the user to press the **PTT** button to respond directly to the call initiator by making a Private Call.

An Off Air Call Set-Up (OACSU) private call allows the user to respond immediately while a Full Off Air Call Set-Up (FOACSU) private call requires user acknowledgment for the call. OACSU type calls are therefore, recommended being used for the Call Alert feature. See [Private Call on page 38](#).

#### 4.9.13.1

### Making Call Alerts

Follow the procedure to make Call Alerts on your radio.

- 1 Press the programmed **One Touch Access** button.

The green LED lights up.

---

- 2 Wait for acknowledgment.

If the Call Alert acknowledgment is received, a positive indicator tone sounds.

If the Call Alert acknowledgment is not received, a negative indicator tone sounds.

---

#### 4.9.13.2

### Responding to Call Alerts

When you receive a Call Alert:

- A repetitive tone sounds.

- The yellow LED blinks.

Press the **PTT** button within 4 seconds of receiving a Call Alert page to respond with a Private Call.

---

#### 4.9.14

### Mute Mode

Mute Mode provides an option to silence all audio indicators on your radio.

When Mute Mode is initiated, all audio indicators are muted except higher priority features such as emergency operations.

When Mute Mode is exited, your radio resumes playing ongoing tones and audio transmissions.



#### **IMPORTANT:**

You can only enable either Face Down or Man Down one at a time. Both features cannot be enabled together.

#### 4.9.14.1

### Turning On Mute Mode

Follow the procedure to turn on Mute Mode.

Access this feature by using the programmed **Mute Mode** button.

---

The following occurs when Mute mode is enabled:

- Positive Indicator Tone sounds.
- The red LED light starts blinking and remains blinking until Mute Mode is exited.
- Radio is muted.
- Mute Mode Timer begins counting down the duration that is configured.

#### 4.9.14.2

### Exiting Mute Mode

This feature can be exited automatically once the Mute Mode Timer expires.

Do one of the following to exit Mute mode manually:

- Press the programmed **Mute Mode** button.
  - Press the **PTT** button on any entry.
- 

The following occurs when Mute mode is disabled:

- Negative Indicator Tone sounds.

- The blinking red LED turns off.
- Your radio unmutes and speaker state is restored.
- If the timer has not expired, Mute mode timer is stopped.



#### **NOTICE:**

Mute Mode is also exited if the user transmits voice or switches to an unprogrammed channel.

#### 4.9.15

### Emergency Operation

An Emergency Alarm is used to indicate a critical situation. You are able to initiate an Emergency at any time even when there is activity on the current channel.

In Capacity Max, the receiving radio can only support a single Emergency Alarm at a time. If initiated, a second Emergency Alarm will override the first alarm.

When an Emergency Alarm is received, the recipient may choose to either delete the alarm and exit the Alarm List, or respond to the Emergency Alarm by pressing the **PTT** button and transmitting non-emergency voice.

Your dealer or system administrator can set the duration of a button press for the programmed **Emergency** button, except for long press, which is similar with all other buttons:

## Short Press

Duration between 0.05 seconds and 0.75 seconds.

## Long Press

Duration between 1.00 second and 3.75 seconds.

The **Emergency** button is assigned with the Emergency On/Off feature. Check with your dealer for the assigned operation of the **Emergency** button.



### NOTICE:

If short press the **Emergency** button is assigned to turn on the Emergency mode, then long press the **Emergency** button is assigned to exit the Emergency mode.

If long press the **Emergency** button is assigned to turn on the Emergency mode, then short press the **Emergency** button is assigned to exit the Emergency mode.

Your radio supports three Emergency Alarms:

- Emergency Alarm
- Emergency Alarm with Call
- Emergency Alarm with Voice to Follow

In addition, each alarm has the following types:

## Regular

Radio transmits an alarm signal and shows audio and/or visual indicators.

## Silent

Radio transmits an alarm signal without any audio or visual indicators. Radio receives calls without any sound through the speaker, until the programmed *hot mic* transmission period is over and/or you press the **PTT** button.

## Silent with Voice

Radio transmits an alarm signal without any audio or visual indicators, but allow incoming calls to sound through the speaker.



### NOTICE:

Only one of the Emergency Alarms above can be assigned to the programmed **Emergency** button or the **Emergency** footswitch.

### 4.9.15.1

## Sending Emergency Alarms

This feature allows you to send an Emergency Alarm, a non-voice signal, which triggers an alert indication on a group of radios. Follow the procedure to send Emergency Alarms on your radio.

Your radio does not display any audio or visual indicators during Emergency mode when it is set to Silent.

- 1 Press the programmed **Emergency On** button.

The green LED lights up.



**NOTICE:**

If programmed, the Emergency Search tone sounds. This tone is muted when the radio transmits or receives voice, and stops when the radio exits Emergency mode. The Emergency Search tone can be programmed by the dealer or system administrator.

- 2 Wait for acknowledgment.

If successful:

- The Emergency tone sounds.
- The green LED blinks.

If unsuccessful after all retries have been exhausted:

- A low-pitched tone sounds. (Applicable to PMUE4426B only)

The radio exits the Emergency Alarm mode.



**NOTICE:**

When configured for Emergency Alarm only, the emergency process consists only of the Emergency Alarm delivery. The emergency ends when an acknowledgment is received from the system, or when channel access attempts have been exhausted.

No voice call is associated with the sending of an Emergency Alarm when operating as Emergency Alarm Only.

#### 4.9.15.2

### Sending Emergency Alarms with Call

This feature allows you to send an Emergency Alarm with Call to a group of radios or a dispatcher. Upon acknowledgment by the infrastructure within the group, a group of radios can communicate over a programmed Emergency channel.

The radio must be configured for Emergency Alarm and Call to perform an emergency call after the alarm process.

- 1 Press the programmed **Emergency On** button.

The green LED lights up.



**NOTICE:**

If your radio is programmed, the Emergency Search tone sounds. This tone is muted when the radio transmits or receives voice, and stops when the radio exits Emergency mode.

If an Emergency Alarm acknowledgment is successfully received:

- The Emergency tone sounds.
- The green LED blinks.

If an Emergency Alarm acknowledgment is not successfully received:

- All retries are exhausted.
- A low-pitched tone sounds.
- The radio exits the Emergency Alarm mode.

- 
- 2 Press the **PTT** button to initiate a voice transmission.

The green LED lights up.

---

- 3 Do one of the following:

- Wait for the Talk Permit Tone to end and speak clearly into the microphone if enabled.
- Wait for the **PTT** Sidetone to end and speak clearly into the microphone if enabled.

- 
- 4 Release the **PTT** button to listen.
- 

- 5 Press the **PTT** button to respond to the call.

If the Channel Free Indication feature is enabled, you hear a short alert tone the moment the transmitting radio releases the **PTT** button, indicating the channel is free for you to respond.

---

- 6 Press the **Emergency Off** button to exit the Emergency mode.



**NOTICE:**

Depending on how your radio is programmed, you may or may not hear a Talk Permit tone. Your radio dealer or system administrator can provide more information on how your radio has been programmed for Emergency.

The Emergency Call initiator may press the programmed **Cancel** button to end an on-going emergency call. The radio returns to a call idle state.



**NOTICE:**

Your radio cannot detect a non-IMPRES microphone that is attached to the rear accessory connector.

When no microphone is detected at the specified programmed connector, your radio checks the alternative connector. Here, your radio gives priority to the detected microphone.

If your radio has Emergency Cycle Mode enabled, repetitions of *hot mic* and receiving period are made for a programmed duration. During Emergency Cycle Mode, received calls sound through the speaker.

If you press the **PTT** button during the programmed receiving period, you hear a prohibit tone, indicating that you should release the **PTT** button. The radio ignores the **PTT** button press and remains in Emergency mode.

If you press the **PTT** button during *hot mic*, and continue to press it after the *hot mic* duration expires, the radio continues to transmit until you release the **PTT** button.

#### 4.9.15.3

### Sending Emergency Alarms with Voice to Follow

This feature allows you to send an Emergency Alarm with Voice to Follow to a group of radios. Your radio microphone is automatically activated, allowing you to communicate with the group of radios without pressing the **PTT** button. This activated microphone state is also known as *hot mic*.

If the Emergency Alarm request fails, the radio does not retry to send the request, and enters the *hot mic* state directly.

**NOTICE:**

Some accessories may not support *hot mic*. Check with your dealer or system administrator for more information.

Follow the procedure to send Emergency Alarms with voice to follow on your radio.

- 1 Press the programmed **Emergency On** button or the **Emergency** footswitch.

The green LED lights up.

- 2 Once the Emergency tone sounds, speak clearly into the microphone.

The radio automatically stops transmitting when:

- The cycling duration between *hot mic* and receiving calls expires, if Emergency Cycle Mode is enabled.
- The *hot mic* duration expires, if Emergency Cycle Mode is disabled.

The red LED blinks. The radio remains in Emergency mode.

---

#### 4.9.15.4

### Receiving Emergency Alarms

The receiving radio can only support a single Emergency Alarm at a time. If initiated, a second Emergency Alarm will override the first alarm. Follow the procedure to receive and view Emergency Alarms on your radio.

When you receive an Emergency Alarm:

- A tone sounds.
- The red LED blinks.

**NOTICE:**

Your radio automatically acknowledges the Emergency Alarm (if enabled).

You can silence the tone. Do one of the following:

- Press the **PTT** button to call the group of radios which received the Emergency Alarm.
- Press any programmable button.

- Exit Emergency mode.

#### 4.9.15.5

### Responding to Emergency Alarms with Call

Follow the procedure to respond to Emergency Alarms with Call on your radio.

When you receive an Emergency Call:

- The Emergency Call Tone sounds if the Emergency Call Indication and Emergency Call Decode Tone is enabled. The Emergency Call Tone will not sound if only the Emergency Call Indication is enabled.
- Your radio unmutes and the incoming call sounds through the speaker.

- 1 If the Channel Free Indication feature is enabled, you hear a short alert tone the moment the transmitting radio releases the **PTT** button, indicating the channel is free for you to respond. Press the **PTT** button to respond to the call.

The green LED lights up.

---

- 2 Wait for the Talk Permit Tone to end and speak clearly into the microphone if enabled.
- 

- 3 Release the **PTT** button to listen.

When the emergency initiating radio responds:

- The red LED blinks.
- 

#### 4.9.15.6

### Exiting Emergency Mode

Press the programmed **Emergency Off** button.

---

Your radio shows the following indications:

- The tone ceased.
- The red LED extinguished.

#### 4.9.16

### Status Message

This feature allows the user to send status messages to other radios.

The Quick Status list is configured by using CPS-RM and comprises up to a maximum of 99 statuses.

The maximum length for each status message is 16 characters.

The Text-to-Speech feature if enabled, allows the radio to audibly indicate the status messages that are received.



**NOTICE:**

Text-to-Speech is configured using CPS. Check with your dealer or system administrator to determine how your radio has been programmed.

### 4.9.16.1

## Sending Status Messages

Follow the procedure below to send a status message.

Press the programmed **One Touch Access** button.

If successful:

- A positive indicator tone sounds.
- The LED turns off.

If unsuccessful:

- A negative indicator tone sounds.

- The LED turns off.

### 4.9.17

## Text Messaging

Your radio is able to receive data, for example a text message, from another radio or a text message application.

There are two types of text messages, Digital Mobile Radio (DMR) Short Text Message and text message. The maximum length of a DMR Short Text Message is 23 characters. The maximum length of a text message is 280 characters, including the subject line. The subject line only appears when you receive messages from e-mail applications.



**NOTICE:**

The maximum character length is only applicable for models with the latest software and hardware. For radio models with older software and hardware, the maximum length of a text message is 140 characters. Contact your dealer for more information.

## 4.9.17.1

## Quick Text Messages

Your radio supports Quick Text messages as programmed by your dealer.

## 4.9.17.1.1

### Sending Quick Text Messages

Follow the procedure to send predefined Quick Text messages on your radio to a predefined alias.

**1** Press the programmed **One Touch Access** button.

---

**2** Wait for acknowledgment.

If successful:

- The green LED lights up.
- A positive indicator tone sounds.

If unsuccessful:

- A negative indicator tone sounds.
- 

## 4.9.18

## Privacy

This feature helps to prevent eavesdropping by unauthorized users on a channel by the use of a software-based scrambling solution. The signaling and user identification portions of a transmission are not scrambled.

Your radio must have privacy enabled on the channel to send a privacy-enabled transmission, although this is not a necessary requirement for receiving a transmission. While on a privacy-enabled channel, the radio is still able to receive clear or unscrambled transmissions.

Your radio only supports Enhanced Privacy. To unscramble a privacy-enabled call or data transmission, your radio must be programmed to have the same Key Value and Key ID for Enhanced Privacy as the transmitting radio.

If your radio receives a scrambled call that is of a different Key Value and Key ID, you hear nothing at all for Enhanced Privacy.

On a privacy-enabled channel, your radio is able to receive clear or unscrambled calls, depending on how your radio is programmed. In addition, your radio may play a warning tone or not, depending on how it is programmed.



### NOTICE:

This feature is not applicable in Citizens Band channels that are in the same frequency.

The green LED lights up when the radio is transmitting, and blinks rapidly when the radio is receiving an ongoing privacy-enabled transmission.



**NOTICE:**

Some radio models may not offer this Privacy feature, or may have a different configuration. Check with your dealer or system administrator for more information.

### 4.9.18.1

## Turning Privacy On or Off

Follow the procedure to turn privacy on or off on your radio.

---

Press the programmed **Privacy** button.

### 4.9.19

## Response Inhibit

This feature helps prevent your radio from responding to any incoming transmissions.



**NOTICE:**

Contact your dealer to determine how your radio has been programmed.

If enabled, your radio does not generate any outgoing transmissions in response to incoming transmissions, such as Radio Check, Call Alert, Radio Disable, Remote Monitor, Automatic Registration Service (ARS), Responding to Private Messages, and Sending GNSS location reports.

Your radio cannot receive Confirmed Private Calls when this feature is enabled. However, your radio is able to manually send transmission.

### 4.9.19.1

## Turning Response Inhibit On or Off

Follow the procedure to enable or disable Response Inhibit on your radio.

---

Press the programmed **Response Inhibit** button.

If successful:

- A positive indicator tone sounds.

If unsuccessful:

- A negative indicator tone sounds.

## 4.9.20

## Stun/Revive

This feature allows you to enable or disable any radio in the system. For example, the dealer or system administrator may want to disable a stolen radio to prevent unauthorized users from using it, and enable the radio when it is recovered.

Once a radio is disabled, the radio sounds a negative indicator tone.

When a radio is stunned, the radio cannot request nor receive any user initiated services on the system that performed the Stun procedure. However, the radio can switch to another system. The radio continues to send GNSS location reports and can be monitored remotely when it was stunned.

**NOTICE:**

The dealer or system administrator may permanently disable a radio. See [Radio Kill on page 67](#) for more information.

## 4.9.21

## Radio Kill

This feature is an enhanced security measure to restrict unauthorized access to a radio.

Radio Kill causes a radio to be rendered inoperable. For example, the dealer may want to kill a stolen or misplaced radio to prevent unauthorized usage.

**NOTICE:**

A killed radio can only be revived at a Motorola Solutions service depot. Contact your dealer for more information.

## 4.9.22

## Lone Worker

This feature prompts an emergency to be raised if there is no user activity, such as any radio button press or activation of the channel selector, for a predefined time.

Following no user activity for a programmed duration, the radio pre-warns you using an audio indicator once the inactivity timer expires.

If there is still no acknowledgment by you before the predefined reminder timer expires, the radio initiates an emergency condition as programmed by the dealer.

## 4.9.23

## Password Lock

You can set a password to restrict access to your radio. Each time you turn on your radio, you are asked to enter the password.

Your radio supports a 4-digit password input.

Your radio is unable to receive calls in locked state.

## 4.9.23.1

### Accessing the Radio by Using Password

Turn on your radio.

- 1 Enter the four-digit password.
  - a To enter the first digit of the password, use the **Channel Selector Knob**.
  - b To move to the next digit, press and hold the **Channel Selector Knob**.
  - c Enter the remaining digit of the password in the same manner.

**NOTICE:**

The use of **Emergency** footswitch cancels password input to access the radio.

---

- 2 Your radio automatically checks the validity of the password when you enter the last digit of the password.
- 

If you enter the password correctly, the radio powers up.

If you enter the wrong password after the first and second attempt, your radio shows the following indications:

- A continuous tone sounds.

Repeat [step 1](#).

If you enter the wrong password after the third attempt, your radio shows the following indications:

- A tone sounds.
- The yellow LED double blinks.
- Your radio enters into locked state for 15 minutes.

Wait for the 15-minute locked state timer to end and then repeat [step 1](#).

**NOTICE:**

If you turn off and turn your radio on again, the 15-minute timer restarts.

## 4.9.23.2

## Unlocking Radios in Locked State

Your radio is unable to receive calls in locked state. Follow the procedure to unlock your radio in locked state.

Do one of the following:

- If the radio is powered on, wait for 15 minutes and then repeat the steps in [Accessing the Radio by Using Password on page 68](#) to access the radio.
- If the radio is powered off, power up the radio. Your radio restarts the 15-minute timer for locked state. A tone sounds. The yellow LED double blinks.

Wait for 15 minutes and then repeat the steps in [Accessing the Radio by Using Password on page 68](#) to access the radio.

## 4.9.24

## Over-the-Air Programming

Your dealer can remotely update your radio by using Over-the-Air Programming (OTAP) without physical connection. Additionally, some settings can also be configured by using OTAP.

When your radio undergoes OTAP, the green LED blinks.

When your radio receives high volume data:

- The channel becomes busy.
- A negative tone sounds if you press the **PTT** button.

Once the programming update is complete, a tone sounds, and your radio restarts (powers off and on again).

If the programming update is unsuccessful, a tone sounds and the red LED blinks once.



### NOTICE:

If the programming update is unsuccessful, the software update failure indications appear every time you turn on your radio. Contact your dealer to reprogram your radio with the latest software to eliminate the software update failure indications.

## 4.9.25

## Wi-Fi Operation

This feature allows you to set up and connect to a Wi-Fi network. Wi-Fi supports updates for radio firmware, codeplug, and resources such as language packs and voice announcement.



### NOTICE:

This feature is applicable to DM4401e only.

Wi-Fi® is a registered trademark of Wi-Fi Alliance®.

Your radio supports WEP/WPA/WPA2-Personal and WPA/WPA2-Enterprise Wi-Fi networks.

### **WEP/WPA/WPA2-Personal Wi-Fi network**

Uses pre-shared key (password) based authentication.

Pre-shared key can be entered by using the menu or CPS/RM.

### **WPA/WPA2-Enterprise Wi-Fi network**

Uses certificate-based authentication.

Your radio must be pre-configured with a certificate.



#### **NOTICE:**

Check with your dealer or system administrator to connect to WPA/WPA2-Enterprise Wi-Fi network.

The programmed **Wi-Fi On or Off** button is assigned by your dealer or system administrator. Check with your dealer or system administrator to determine how your radio has been programmed.

Voice Announcements for the programmed **Wi-Fi On or Off** button can be customized through CPS according to user requirements. Check with your dealer or system administrator for more information.

#### 4.9.25.1

### **Turning Wi-Fi On or Off**

Press the programmed **Wi-Fi On or Off** button. Voice Announcement sounds Turning On Wi-Fi or Turning Off Wi-Fi.

---

#### 4.9.25.2

### **Connecting to a Network Access Point**

When you turn on Wi-Fi, the radio scans and connects to a network access point.



#### **NOTICE:**

The programmed **Wi-Fi Status Query** button is assigned by your dealer or system administrator. Voice Announcements for the programmed **Wi-Fi Status Query** button can be customized according to user requirements by using CPS. Check with your dealer or system administrator to determine how your radio has been programmed.

The WPA-Enterprise Wi-Fi network access points are pre-configured. Check with your dealer or system administrator to determine how your radio has been programmed.

Press the programmed **Wi-Fi Status Query** button for the connection status using Voice Announcement.

Voice Announcement sounds when Wi-Fi is Off, Wi-Fi is On but No Connection, or Wi-Fi is On with Connection.

#### 4.9.26

## Dynamic Group Number Assignment (DGNA)

Dynamic Group Number Assignment (DGNA) is a feature which allows the console to assign and remove a new talkgroup from your radio over the air.

When the console assigns DGNA to your radio, your radio is in DGNA mode:

- A tone sounds.

When the console removes DGNA from your radio, your radio returns to the previous talkgroup:

- A tone sounds.

Depending on how your radio is programmed, you can view, edit, and listen to the original scan lists channels and the non-DGNA talkgroups.

When your radio is in DGNA mode, pressing the PTT button allows you to communicate only with the current DGNA talkgroup. To communicate with the previous non-DGNA talkgroup, program the **One Touch Access** button. See [Making Non-DGNA Calls on page 72](#).



#### NOTICE:

Check with your dealer or system administrator to determine how your radio has been programmed.

#### 4.9.26.1

## Making DGNA Calls

When your radio is in DGNA mode, press the **PTT** button to make the call.

- A DGNA tone sounds.



#### NOTICE:

If your radio is not in DGNA mode and you press the **One Touch Access** button, your radio sounds a tone, indicating error.

#### 4.9.26.2

### Making Non-DGNA Calls

1 Press the programmed **One Touch Access** button.

- A positive tone sounds.
- Voice Announcement sounds One Touch Replaced Call.



**NOTICE:**

If your radio is not in DGNA mode and you press the **One Touch Access** button, your radio sounds a negative tone, indicating error.

---

2 Press **PTT** button before a negative tone sounds.



**NOTICE:**

A PTT press after the tone makes call to the DGNA talkgroup.

#### 4.9.26.3

### Receiving and Responding to DGNA Calls

When you receive a DGNA call:

- A DGNA tone sounds.
- Your radio unmutes and the incoming call sounds through the speaker.

---

1 Press the **PTT** button to respond to the call.

---

2 Release the **PTT** button to listen.

#### 4.10

### Utilities

---

This chapter explains the operations of the utility functions available in your radio.

#### 4.10.1

### Power Levels

You can customize the power setting to high or low for each channel.

#### High

This enables communication with radios located at a considerable distance from you.

## Low

This enables communication with radios in closer proximity.

### 4.10.1.1

## Setting Power Levels

Follow the procedure to set the power levels on your radio.

Press the programmed **Power Level** button.

If successful:

- The Positive Indicator Tone sounds.
- Radio transmits at low power.

If unsuccessful:

- The Negative Indicator Tone sounds.
  - Radio transmits at high power.
- 

### 4.10.2

## Turning Radio Tones/Alerts On or Off

You can enable and disable all radio tones and alerts, if needed, except for incoming Emergency alert tone . Follow the procedure to turn tones and alerts on or off on your radio.

Press the programmed **All Tones/Alerts** button.

If successful:

- The Positive Indicator Tone sounds.
- All tones and alerts are turned on.

If unsuccessful:

- The Negative Indicator Tone sounds.
  - All tones and alerts are turned off.
- 

### 4.10.3

## Turning Horns/Lights On or Off

Your radio is able to notify you of an incoming call through the horns and lights feature. When activated, an incoming call sounds the horn and turns on the lights of your vehicle.

This feature needs to be installed through your radio rear accessory connector by your dealer. Follow the procedure to turn all horns and lights on or off on your radio.

Press the programmed **Horns/Lights** button.

If successful:

- The Positive Indicator Tone sounds.
- Horns and Lights feature is on.

If unsuccessful:

- The Negative Indicator Tone sounds.
  - Horns and Lights feature is off.
- 

#### 4.10.4

### Turning Public Address System On or Off

Follow the procedure to enable or disable the internal public address (PA) system of your radio.

Press the programmed **Public Address** button.

One of the following tone sounds:

If successful:

- The Positive Indicator Tone sounds.
- The Public Address system is turned on.

If unsuccessful:

- The Negative Indicator Tone sounds.
  - The Public Address system is turned off.
- 

#### 4.10.5

### Turning External Public Address System On or Off

Follow the procedure to enable or disable the external public address (PA) system of your radio.

Press the programmed **Ext Public Address** button.

One of the following tone sounds:

If successful:

- The Positive Indicator Tone sounds.
- The external public address system is turned on.

If unsuccessful:

- The Negative Indicator Tone sounds.

- The external public address system is turned off.
- 

- All tones and alerts are turned off.
- 

#### 4.10.6

### Turning Voice Announcement On or Off

This feature enables the radio to audibly indicate the current zone or channel the user has just assigned, or the programmable button the user has just pressed.

This audio indicator can be customized according to customer requirements. Follow the procedure to turn Voice Announcement on or off on your radio.

Press the programmed **Voice Announcement** button.

If successful:

- The Positive Indicator Tone sounds.
- All tones and alerts are turned on.

If unsuccessful:

- The Negative Indicator Tone sounds.

#### 4.10.7

### Turning Option Board On or Off

Option board capabilities within each channel can be assigned to programmable buttons. A channel can support up to 6 option board features. Follow the procedure to turn option board on or off on your radio.

Press the programmed **Option Board** button.

---

#### 4.10.8

### Text-to-Speech

The Text-to-Speech feature can only be enabled by your dealer. If Text-to-Speech is enabled, the Voice Announcement feature is automatically disabled. If Voice Announcement is enabled, then the Text-to-Speech feature is automatically disabled.

This audio indicator can be customized per customer requirements.

#### 4.10.8.1

### Setting Text-to-Speech

Follow the procedure to set the Text-to-Speech feature.

Press the programmed **Text-to-Speech** button to listen to the received text message.

---

#### 4.10.9

### Turning Intelligent Audio On or Off

Your radio automatically adjusts the audio volume to overcome current background noise in the environment, inclusive of both stationary and non-stationary noise sources. This is a receive-only feature and does not affect transmission audio. Follow the procedure to turn Intelligent Audio on or off on your radio.

Press the programmed **Intelligent Audio** button.



**NOTICE:**

This feature is not applicable during a Bluetooth session.

#### 4.10.10

### Turning the Acoustic Feedback Suppressor Feature On or Off

This feature allows you to minimize acoustic feedback in received calls.

Press the programmed **Acoustic Feedback Suppressor** button.

You hear a positive indicator tone, indicating that Acoustic Feedback Suppressor is now enabled.

You hear a negative indicator tone, indicating that the radio is unable to activate Acoustic Feedback Suppressor.

#### 4.10.11

### Turning Trill Enhancement On or Off

You can enable this feature when you are speaking in a language that contains many words with alveolar trill (rolling "R") pronunciations. Follow the procedure to turn Trill Enhancement on or off on your radio.

Press the programmed **Trill Enhancement** button to toggle the feature on or off.

If successful:

- The Positive Indicator Tone sounds.

- All tones and alerts are turned on.

If unsuccessful:

- The Negative Indicator Tone sounds.
  - All tones and alerts are turned off.
- 

#### 4.10.12

## Turning Global Navigation Satellite System On or Off

Global Navigation Satellite System (GNSS) is a satellite navigation system that determines the radio precise location. GNSS includes Global Positioning System (GPS), Global Navigation Satellite System (GLONASS), and BeiDou Navigation Satellite System (BDS).



### **NOTICE:**

Selected radio models may offer GPS, GLONASS, and BDS. GNSS constellation is configured by using CPS. Check with your dealer or system administrator to determine how your radio has been programmed.

---

## Connect Plus

---

Connect Plus is a full trunking solution based on DMR technology. Connect Plus uses a dedicated control channel for channel requests and allocations.

### 5.1

## Additional Radio Controls in Connect Plus Mode

---

This chapter explains the additional radio controls available to the radio user through preprogrammed means such as programmable buttons and assignable radio functions.

### 5.1.1

## Push-To-Talk (PTT) Button

The **PTT** button on the side of the radio serves two basic purposes:

- While a call is in progress, the **PTT** button allows the radio to transmit to other radios in the call.

Press and hold the **PTT** button to talk. Release the **PTT** button to listen.

The microphone is activated when the **PTT** button is pressed.

- While a call is not in progress, the **PTT** button is used to make a new call (see [Making a Radio Call on page 87](#)).

If the Talk Permit Tone is enabled, wait until the short alert tone ends before talking.

### 5.1.2

## Programmable Buttons

Your dealer can program the programmable buttons as shortcuts to radio functions depending on the duration of a button press:

### Short press

Pressing and releasing rapidly.

### Long press

Pressing and holding for the programmed duration.



### NOTICE:

The programmed duration of a button press is applicable for all assignable radio/utility functions or settings. See [Emergency Operation on page 99](#) for more information on the programmed duration of the *Emergency* button.

### 5.1.2.1

## Assignable Radio Functions

### Bluetooth® Audio Switch

Toggles audio routing between internal radio speaker and external Bluetooth-enabled accessory.

### Bluetooth Connect

Initiates a Bluetooth find-and-connect operation.

### Bluetooth Disconnect

Terminates all existing Bluetooth connections between your radio and any Bluetooth-enabled devices.

### Bluetooth Discoverable

Enables your radio to enter Bluetooth Discoverable Mode.

### Busy Queue Cancellation

Exits the busy mode when a non-Emergency call in the Busy Queue was initiated. Emergency calls, once accepted into the Busy Queue, cannot be cancelled.

### Channel Announcement

Plays zone and channel announcement voice messages for the current channel.

### Emergency On/Off

Depending on the programming, initiates or cancels an emergency.

### Horns/Lights

Toggles horns and lights feature on or off.

### Intelligent Audio

Toggles intelligent audio on or off.

### Mic AGC On/Off

Toggles the internal microphone automatic gain control (AGC) on or off.

### One Touch Access

Directly initiates a predefined Private Call, a Call Alert, a Quick Text message, or Home Revert.

### Phone Exit

Ends a Phone Call.

### Privacy

Toggles privacy on or off.

### Reset Home Channel

Sets a new home channel.

### Ring Alert Type

Provides direct access to the Ring Alert Type Setting.

### Roam Request

Requests to search for a different site.

### Scan

Toggles scan on or off.

### **Silence Home Channel Reminder**

Mutes the Home Channel Reminder.

### **Site Lock On/Off**

When toggled on, the radio searches the current site only. When toggled off, the radio searches other sites in addition to the current site.

### **Voice Announcement On/Off**

Toggles voice announcement on or off.

### **Wi-Fi**

Toggles Wi-Fi on or off.

### **Zone Toggle**

Allows radio user to toggle between Zone 1 and Zone 2.

#### 5.1.2.2

## **Assignable Settings or Utility Functions**

### **AF Suppressor**

Toggles the Acoustic Feedback Suppressor feature on or off.

### **All Tones/Alerts**

Toggles all tones and alerts on or off.

### **Backlight Brightness**

Adjusts the brightness level.

### **Channel Up/Down**

Depending on the programming, changes channel to previous or next channel.

### **Global Navigation Satellite System (GNSS)**

Toggles the satellite navigation system on or off.

### **Power Level**

Toggles transmit power level between high and low.

### **Unassigned**

Indicates that the button function has not yet been assigned.

#### 5.1.3

## **Identifying Status Indicators in Connect Plus Mode**

## 5.1.3.1

**LED Indicator**

The LED indicator shows the operational status of your radio.

|                                  |  |
|----------------------------------|--|
| <b>Blinking red</b>              | Radio is transmitting at low battery condition, receiving an emergency transmission or has failed the self-test upon powering up, or has moved out of range if radio is configured with Auto-Range Transponder System. Mute Mode is enabled. |
| <b>Rapidly blinking red</b>      | Radio is receiving over-the-air file transfer (Option Board firmware file, Network Frequency file or Option Board Codeplug file) or upgrading to a new Option Board firmware file.   |
| <b>Blinking green and yellow</b> | Radio is receiving a Call Alert, received a text message or Scan is enabled and is receiving activity.   |
| <b>Solid yellow</b>              | Radio is in Bluetooth Discoverable Mode.   |

|                               |   |
|-------------------------------|---|
| <b>Double blinking yellow</b> | Radio is actively searching for a new site. |
|-------------------------------|---|

|                        |   |
|------------------------|---|
| <b>Blinking yellow</b> | Radio is receiving a Call Alert or Scan is enabled and is idle (radio will remain muted to any activity). |
|------------------------|---|

|                    |                                       |
|--------------------|---------------------------------------|
| <b>Solid green</b> | Radio is powering up or transmitting. |
|--------------------|---------------------------------------|

|                       |   |
|-----------------------|---|
| <b>Blinking green</b> | Radio is powering up, receiving a call or data. |
|-----------------------|---|

|                              |  |
|------------------------------|--|
| <b>Double blinking green</b> | Radio is receiving a privacy-enabled call. |
|------------------------------|--|

**NOTICE:**

Upon a **PTT** button press, if the radio is programmed for polite operation, the radio automatically determines whether a transmission is permitted via a Talk Permit or a Talk Denial tone.



## 5.1.3.2

## Indicator Tones

The following are the tones that sound through the radio speaker.

High pitched tone  Low pitched tone 

Indicator tones provide you with audible indications of the status after an action to perform a task is taken.

|   |                         |
|---|-------------------------|
|  | Positive Indicator Tone |
|  | Negative Indicator Tone |

## 5.1.3.3

## Alert Tones

Alert tones provide you with audible indications of the status, or response to data received on the radio.

|   |   |
|---|---|
| <b>Continuous Tone</b><br> | A monotone sound.<br>Sounds continuously until termination. |
|---|---|

**Periodic Tone**

Sounds periodically depending on the duration set by the radio. Tone starts, stops, and repeats itself.

**Repetitive Tone**

A single tone that repeats itself until it is terminated by the user.

**Momentary Tone**

Sounds only once for a short period of time defined by the radio.

## 5.1.4

## Switching Between Connect Plus and Non-Connect Plus Modes

To switch to a non-Connect Plus mode, you must change to another zone, if programmed by your dealer or system administrator. Check with your dealer or system administrator to see if your radio has been programmed with non-Connect Plus zones, and what features are available while operating in non-Connect Plus zones.

## 5.2

## Making and Receiving Calls in Connect Plus Mode

---

This section explains general radio operations and call features that are available in your radio.

## 5.2.1

### Selecting a Site

A site provides coverage for a specific area. A Connect Plus site has a site controller and a maximum of 15 repeaters. In a multi-site network, the Connect Plus radio will automatically search for a new site when the signal level from the current site drops to an unacceptable level.

## 5.2.1.1

#### Roam Request

A Roam Request tells the radio to search for a different site, even if the signal from the current site is acceptable.

If there are no sites available:

- The radio continues to search through the list of sites.

- The radio will return to the previous site, if the previous site is still available.

**NOTICE:**

This is programmed by your dealer.

Press the programmed **Roam Request** button.

You hear a tone, indicating the radio has switched to a new site.

---

## 5.2.1.2

#### Site Lock On/Off

When toggled on, the radio searches the current site only. When toggled off, the radio searches other sites in addition to the current site.

Press the programmed **Site Lock** button.

If the **Site Lock** function is toggled on:

- You hear a positive indicator tone, indicating the radio has locked to the current site.

If the **Site Lock** function is toggled off:

- You hear a negative indicator tone, indicating the radio is unlocked.
- 

### 5.2.2

## Selecting a Zone

The radio can be programmed with a maximum of 16 Connect Plus Zones and each Connect Plus zone contains a maximum of 16 assignable positions on the Channel Selector Knob.

Each assignable knob position can be used to start one of the following voice call types:

- Group Call
- Multi-group Call
- Site All Call
- Private Call

---

Press the programmed **Zone Toggle** button.

---

### 5.2.3

## Using Multiple Networks

If your radio has been programmed to use multiple Connect Plus networks, you can select a different network by switching to the Connect Plus zone that is assigned to the desired network. These network-to-zone assignments are configured by your dealer through radio programming.

### 5.2.4

## Selecting a Call Type

Use the Channel Selector Knob to select a call type. This can be a Group Call, Multi-group Call, Site All Call or Private Call, depending on how your radio is programmed. If you change the Channel Selector Knob to a different position (that has a call type assigned to it), this causes the radio to re-register with the Connect Plus site. The radio registers with the Registration Group ID that has been programmed for the new Channel Selector Knob position call type.

If you select a position that has no call type assigned to it, your radio sounds a continuous tone. Your radio does not operate when selected to an unprogrammed channel, use

the Channel Selector Knob to select a programmed channel instead.

Once the required zone is set (if you have multiple zones in your radio), turn the programmed Channel Selector Knob to select the call type.

---

### 5.2.5

## Receiving and Responding to a Radio Call

Once the channel, subscriber ID or call type is set, you can proceed to receive and respond to calls.

The LED lights up solid green while the radio is transmitting and blinks green when the radio is receiving.



#### **NOTICE:**

The LED lights up solid green while the radio is transmitting and blinks green rapidly when the radio is receiving a privacy-enabled call. To unscramble a privacy-enabled call, your radio must have the same Privacy Key, OR the same Key Value and Key ID (programmed by your dealer), as the transmitting radio (the radio you are receiving the call from).

See [Privacy on page 104](#) for more information.

### 5.2.5.1

## Receiving and Responding to a Group Call

To receive a call from a group of users, your radio must be configured as part of that group.

The LED blinks green. Your radio unmutes and the incoming call sounds through the radio speaker.

- 1 Hold the microphone 1 to 2 inches (2.5 to 5.0 cm) from your mouth.

The LED lights up solid green.

---

- 2 Wait for one of the Talk Permit Tone to finish (if enabled), and speak clearly into the microphone.
- 

- 3 Release the **PTT** button to listen.

If there is no voice activity for a predetermined period of time, the call ends.

---



#### **NOTICE:**

See [Making a Group Call on page 88](#) for details on making a Group Call.

## 5.2.5.2

## Receiving and Responding to a Private Call

A Private Call is a call from an individual radio to another individual radio.

When you receive a Private Call, the LED blinks green. Your radio unmutes and the incoming call sounds through the speaker of the radio.

- 1 Hold the microphone 1 to 2 inches (2.5 to 5.0 cm) from your mouth.

---

- 2 Press the **PTT** button to respond to the call.  
The LED lights up solid green.

---

- 3 Wait for the Talk Permit Tone to finish (if enabled), and speak clearly into the microphone.

---

- 4 Release the **PTT** button to listen.

---

If there is no voice activity for a predetermined period of time, the call ends.

See [Making a Private Call on page 88](#) for details on making a Private Call.

## 5.2.5.3

## Receiving a Site All Call

A Site All Call is a call from an individual radio to every radio on the site. It is used to make important announcements requiring the user's full attention.

When you receive an Site All Call, a tone sounds and the LED blinks green.

Your radio unmutes and the incoming call sounds through the radio speaker.

A Site All Call does not wait for a predetermined period of time before ending.

You cannot respond to a Site All Call.

**NOTICE:**

The radio stops receiving the Site All Call if you switch to a different channel while receiving the call. During a Site All Call, you will not be able to use any programmed button functions until the call ends.

#### 5.2.5.4

### Receiving an Inbound Private Phone Call

When you receive an Inbound Private Phone Call, the LED blinks green. The radio unmutes and the incoming private phone call sounds through the radio's speaker.

- 1 Press and hold the **PTT** button to answer and talk. Release the **PTT** button to listen.
- 

- 2 Press preprogrammed **Phone Exit** button to end the call.

A short feedback tone sounds.

---

#### 5.2.5.5

### Receiving an Inbound Phone Talkgroup Call

When you receive an Inbound Phone Talkgroup Call, the LED blinks green. The radio unmutes and the incoming group call sounds through the radio's speaker.

Press the **PTT** button to talk and release it to listen.

---

#### 5.2.5.6

### Inbound Phone Multi-Group Call

When you receive an Inbound Phone Multi-Group Call, the LED blinks green. The radio unmutes and the incoming multi-group call sounds through the radio speaker.

#### 5.2.6

### Making a Radio Call

After selecting your channel, you can select a subscriber alias or ID, or group alias or ID by using:

- The Channel Selector Knob.
- A programmed **One Touch Access** button – The One Touch Access feature allows you to make a Private Call to a predefined ID easily. This feature can be assigned to a short or long programmable button press. You can only have one ID assigned to a **One Touch Access**

button. Your radio can have multiple **One Touch Access** buttons programmed.



**NOTICE:**

Your radio must have the Privacy feature enabled on the channel to send a privacy-enabled transmission. Only target radios with the same Key Value and Key ID as your radio will be able to unscramble the transmission.

See [Privacy on page 104](#) for more information.

5.2.6.1

## Making a Call

This feature allows the radio users to make different call types : Group Call, Private Call, Site All Call, Multi-group Call.

5.2.6.1.1

### Making a Group Call

To make a call to a group of users, your radio must be configured as part of that group.

- 1 Select the channel with the active group alias or ID.  
See [Selecting a Call Type on page 84](#).
- 

- 2 Hold the microphone 1 to 2 inches (2.5 to 5.0 cm) from your mouth.
- 

- 3 Press the **PTT** button to make the call.  
The LED lights up solid green.
- 

- 4 Wait for the Talk Permit Tone to finish (if enabled), and speak clearly into the microphone.
- 

- 5 Release the **PTT** button to listen.

When the target radio responds, the LED blinks green.

If there is no voice activity for a predetermined period of time, the call ends.

---

5.2.6.1.2

### Making a Private Call

While you can receive and/or respond to a Private Call initiated by an authorized individual radio, your radio must be programmed for you to initiate a Private Call.

You will hear a negative indicator tone, when you make a Private Call using the **One Touch Access** button, or the Channel Selector Knob, if this feature is not enabled.

- 1 Do one of the following.
    - Select the channel with the active subscriber alias or ID. See [Selecting a Call Type on page 84](#).
    - Press the programmed **One Touch Access** button.
- 

- 2 Hold the microphone 1 to 2 inches (2.5 to 5.0 cm) from your mouth.
- 

- 3 Press the **PTT** button to make the call.  
The LED lights up solid green.
- 

- 4 Wait for the Talk Permit Tone to finish (if enabled), and speak clearly into the microphone.
- 

- 5 Release the **PTT** button to listen.  
When the target radio responds, the LED blinks green.  
If there is no voice activity for a predetermined period of time, the call ends. You hear a short tone.
- 

## Making a Site All Call

This feature allows you to transmit to all users on the site that are currently not engaged in another call. Your radio must be programmed to allow you to use this feature.

Users on the channel/site cannot respond to an Site All Call.

- 1 Select the channel with the active Site All Call group alias. See [Selecting a Call Type on page 84](#).
- 

- 2 Hold the microphone 1 to 2 inches (2.5 to 5.0 cm) from your mouth.
- 

- 3 Press the **PTT** button to make the call.  
The LED lights up solid green.
- 

- 4 Wait for the Talk Permit Tone to finish (if enabled), and speak clearly into the microphone.
-

## 5.2.6.1.4

## Making a Multi-group Call

This feature allows you to transmit to all users on multiple groups. Your radio must be programmed to allow you to use this feature.

**NOTICE:**

Users on the groups cannot respond to a Multi-group Call.

- 1 Turn the Channel Selector Knob to select the Multi-group alias or ID.
- 

- 2 Press the **PTT** button to make the call.

The LED lights up solid green.

Wait for the Talk Permit Tone to finish (if enabled) and speak clearly into the microphone.

---

## 5.2.6.2

## Making a Private Call with a One Touch Call Button

The One Touch Call feature allows you to easily make a Private Call to a pre-defined Private Call alias or ID. This feature can be assigned to a short or long programmable button press.

You can **ONLY** have one alias or ID assigned to a One Touch Call button. Your radio can have multiple One Touch Call buttons programmed.

- 1 Press the programmed **One Touch Call** button to make a Private Call to the pre-defined Private Call alias or ID.
- 

- 2 Hold the microphone 1 to 2 inches (2.5 to 5.0 cm) from your mouth.
- 

- 3 Press the **PTT** button to make the call.  
The LED lights up solid green.
- 

- 4 Wait for the Talk Permit Tone to finish (if enabled) and speak clearly into the microphone.
- 

- 5 Release the **PTT** button to listen.

When the target radio responds, the LED blinks green.

If there is no voice activity for a predetermined period of time, the call ends.

---

### 5.3

## Advanced Features in Connect Plus Mode

---

This chapter explains the operations of the features available in your radio.

### 5.3.1

## Home Channel Reminder

This feature provides a reminder when the radio is not set to the home channel for a period of time.

If this feature is enabled by using the CPS, the Home Channel Reminder tone and announcement sound periodically when the radio is not set to the home channel for a period of time.

You can respond to the reminder by performing one of the following actions:

- Return to the home channel.

- Mute the reminder temporarily by using the programmable button.
- Set a new home channel by using the programmable button.

### 5.3.2

## Auto Fallback

Auto Fallback is a system feature that allows you to continue to make and receive non-emergency calls on the selected Group Contact, if certain types of failures occur in the Connect Plus system.

If one of these failures occurs, your radio attempts to roam to a different Connect Plus site. This search process may result in your radio finding an operable Connect Plus site, or it may result in your radio finding a Fallback Channel (if your radio is enabled for Auto Fallback).

A Fallback Channel is a repeater that is normally part of an operable Connect Plus site, but cannot communicate with either the site controller or Connect Plus network at that moment. In Fallback mode, the repeater operates as a single digital repeater. Auto Fallback Mode supports non-emergency Group Calls only. No other call types are supported in Fallback Mode.

## 5.3.2.1

## Indications of Auto Fallback Mode

When your radio is using a Fallback channel, you hear the intermittent Fallback Tone approximately once every 15 seconds (except while transmitting). Your radio only permits PTT on the selected Group Contact (Group Call, Multigroup Call, or Site All Call). It does not allow you to make other types of calls.

## 5.3.2.2

## Making/Receiving Calls in Fallback Mode

**NOTICE:**

Calls are heard only by radios that are monitoring the same Fallback channel and selected to the same Group. Calls are not networked to other sites or other repeaters.

Emergency voice calls or Emergency Alerts are not available in Fallback mode. If you press the emergency button in Fallback mode, the radio provides an invalid key press tone.

Private (radio to radio) and Phone calls are not available in Fallback mode. If you attempt a call to a private contact, you will receive a denial tone. At this point you should select a desired group contact. Other non-supported calls include Remote Monitor, Call Alert, Radio Check, Radio Enable, Radio Disable, Text messaging, Location Updates, and packet data calls.

Enhanced Traffic Channel Access (ETCA) is not supported in Auto Fallback mode. If two or more radio users press **PTT** at the same time (or at almost the same time), it is possible that both radios transmit until **PTT** is released. In this event, it is

possible that none of the transmissions will be understood by receiving radios.

Making calls in Fallback mode is similar to normal functioning. Simply select the group contact you wish to use (using the radio's normal channel selection method), and then press the **PTT** to start your call. It is possible that the channel may be in use already by another group. If the channel is in use, you receive a busy tone. You may select Group, Multi-group or Site All Call contacts using your radio's normal channel selection method. While the radio is operating on the Fallback Channel, the Multigroup operates just like other Groups. It is only heard by radios that are currently selected to the same Multi-group.

### 5.3.2.3

## Returning to Normal Operation

If the site returns to normal trunking operation while you are in range of your Fallback repeater, your radio automatically exits Auto Fallback mode. You hear a registration "beep" when the radio successfully registers. If you are in the range of an operable site (that is not in Fallback mode), you may press the Roam Request button (if programmed for your radio) to force your radio to search for and register on an available site. If no other site is available, your radio returns to Auto Fallback mode after searching is complete.

If you drive out of coverage of your Fallback repeater, your radio enters Search mode.

### 5.3.3

## Scan

This feature allows your radio to monitor and join calls for groups defined in a pre-programmed scan list. When scan is enabled, the LED blinks yellow when idle.

### 5.3.3.1

## Starting and Stopping Scan



### NOTICE:

This procedure turns the Scan feature On or Off for all Connect Plus zones with the same Network ID as your currently selected zone.

You can start and stop scanning by pressing the programmed **Scan** button.

- A tone sounds indicating that Scan has been turned on or off.
- When Scan is enabled, the tone's pitch increases.
- When Scan is disabled, the tone's pitch decreases.

## 5.3.3.2

## Responding to a Transmission During a Scan

During scanning, your radio stops on a group where activity is detected. The radio continuously listens for any member in the scan list when idle on the control channel.

1 Hold the microphone 1 to 2 inches (2.5 to 5.0 cm) from your mouth.

---

2 Press the **PTT** button during hang time.  
The LED lights up solid green.

---

3 Wait for the Talk Permit Tone to finish (if enabled), and speak clearly into the microphone.

---

4 Release the **PTT** button to listen.  
If you do not respond within the hang time, the radio returns to scanning other groups.

---

## Turning Scan On or Off

**NOTICE:**

This procedure turns the Scan feature On or Off for all zones with the same Network ID as your currently selected zone.

When Scan is on and you are not participating in a call, the LED blinks green and yellow.

The procedure for turning Scan on or off depends on how your radio is programmed. If programmed with a Scan On/Off button, use the button to toggle the feature on or off.

- A tone sounds indicating that Scan has been turned on or off.
- When Scan is enabled, the tone's pitch increases.

## 5.3.4

- When Scan is disabled, the tone's pitch decreases.

### 5.3.5

## Understanding Scan Operation



### NOTICE:

If you scan into a call for a group that is not assigned to a channel position in the currently selected zone and you miss the call's Hang Time, switch to the proper zone and then select the group's channel position to talk back to that group.

There are some circumstances in which you can miss calls for groups that are in your scan list. When you miss a call for one of the following reasons, this does not indicate a problem with your radio. This is a normal scan operation for Connect Plus.

- Scan feature is not turned on (check for LED blinking yellow).
- You are participating in a call already.
- No member of the scanned group is registered at your site (Multisite systems only).

### 5.3.6

## Scan Talkback

If your radio scans into a call from the selectable group scan list, and if the **PTT** button is pressed during the scanned call, the operation of the radio depends on whether Scan Talkback was enabled or disabled during radio programming.

### Scan Talkback Disabled

The radio leaves the scanned call and attempts to transmit on the contact for the currently selected channel position. After the Call Hang Time on the currently selected contact expires, the radio returns to the home channel and starts the Scan Hang Time Timer. The radio resumes group scan after its Scan Hang Time Timer expires.

### Scan Talkback Enabled

If the **PTT** button is pressed during the Group Hang Time of the scanned call, the radio attempts to transmit to the scanned group.



#### **NOTICE:**

If you scan into a call for a group that is not assigned to a channel position in the currently selected zone and you miss the Hang Time of the call, switch to the proper zone and then select the channel position of the group to talk back to that group.

### 5.3.7

## Editing Priority for a Talkgroup

The Priority Monitor feature allows the radio to automatically receive transmission from the talkgroup with higher priority when it is in another call. A tone sounds when the radio switches to the call with higher priority. The MOTOTRBO Connect Plus Option Board CPS can configure two levels of priority for the talkgroups: P1 and P2. P1 has higher priority than P2.



#### **NOTICE:**

If Default Emergency Revert Group ID is configured in MOTOTRBO Connect Plus Option Board CPS, there are three levels of priority for talkgroups: P0, P1, and P2. P0 is the permanent Emergency Revert Group ID and the highest priority. Check with your dealer or system administrator for more information.

### 5.3.8

## Call Indicator Settings

This feature allows the radio users to configure call or text message ringing tones.

### 5.3.8.1

## Escalating Alarm Tone Volume

You can program your radio to continually alert you when a radio call remains unanswered. This is done by

automatically increasing the alarm tone volume over time. This feature is known as Escalart.

### 5.3.9

## Call Alert Operation

Call Alert paging enables you to alert a specific radio user to call you back when they are able to do so.

This feature is accessible by using a programmed **One Touch Access** button.

### 5.3.9.1

## Responding to Call Alerts

When you receive a Call Alert:

- A repetitive tone sounds.
- The yellow LED blinks.

Press the **PTT** button within 4 seconds of receiving a Call Alert page to respond with a Private Call.

---

### 5.3.9.2

## Making a Call Alert with the One Touch Access Button

Press the programmed **One Touch Access** button to make a Call Alert to the predefined alias.

The LED lights up solid green when your radio is sending the Call Alert.

If the Call Alert acknowledgement is received, a positive indicator tone sounds.

If the Call Alert acknowledgement is not received, a negative indicator tone sounds.

### 5.3.10

## Mute Mode

Mute Mode provides an option to silence all audio indicators on your radio.

When Mute Mode is initiated, all audio indicators are muted except higher priority features such as emergency operations.

When Mute Mode is exited, your radio resumes playing ongoing tones and audio transmissions.



### **IMPORTANT:**

You can only enable either Face Down or Man Down one at a time. Both features cannot be enabled together.

#### 5.3.10.1

## Turning On Mute Mode

Follow the procedure to turn on Mute Mode.

Access this feature by using the programmed **Mute Mode** button.

---

The following occurs when Mute mode is enabled:

- Positive Indicator Tone sounds.
- The red LED light starts blinking and remains blinking until Mute Mode is exited.
- Radio is muted.
- Mute Mode Timer begins counting down the duration that is configured.

#### 5.3.10.2

## Exiting Mute Mode

This feature can be exited automatically once the Mute Mode Timer expires.

Do one of the following to exit Mute mode manually:

- Press the programmed **Mute Mode** button.
  - Press the **PTT** button on any entry.
- 

The following occurs when Mute mode is disabled:

- Negative Indicator Tone sounds.
- The blinking red LED turns off.
- Your radio unmutes and speaker state is restored.
- If the timer has not expired, Mute mode timer is stopped.



### **NOTICE:**

Mute Mode is also exited if the user transmits voice or switches to an unprogrammed channel.

## 5.3.11

## Emergency Operation



### NOTICE:

If your radio is programmed for Silent or Silent with Voice emergency initiation, in most cases it automatically exits silent operation after the Emergency Call or Emergency Alert is finished. The exception to this rule is when Emergency Alert is the configured Emergency Mode and Silent is the configured Emergency Type. If your radio is programmed in this manner, the silent operation continues until you cancel silent operation by pressing **PTT** or the button configured for Emergency Off.

Emergency voice calls and Emergency Alerts are not supported when operating in Connect Plus Auto Fallback mode. For more information see the [Auto Fallback on page 91](#).

An Emergency Alert is used to indicate a critical situation. You can initiate an Emergency at any time, in any state, even when there is activity on the current channel. Pressing the **Emergency** button initiates the programmed Emergency mode. The programmed Emergency mode may also be initiated by triggering the optional Man Down

feature. The Emergency feature may be disabled in your radio.

Your dealer can set the duration of a button press for the programmed **Emergency** button, except for long press, which is similar with all other buttons:

### Short press

Between 0.05 seconds and 0.75 seconds.

### Long press

Between 1.00 second and 3.75 seconds.

The **Emergency** button is assigned with the Emergency On/Off feature. Check with your dealer for the assigned operation of the **Emergency** button.

- If the short press for the **Emergency** button is assigned to turn on the Emergency mode, then the long press for the **Emergency** button is assigned to exit the Emergency mode.
- If the long press for the **Emergency** button is assigned to turn on the Emergency mode, then the short press for the **Emergency** button is assigned to exit the Emergency mode.

When your radio is selected to a Connect Plus zone, it supports three Emergency modes:

### **Emergency Call**

You must press the **PTT** button to talk on the assigned emergency time slot.

### **Emergency Call with Voice to Follow**

For the first transmission on the assigned emergency time slot, the microphone is automatically unmuted and you may talk without pressing the **PTT** button. The microphone stays “hot” in this fashion for a time period programmed into the radio. For subsequent transmissions in the same Emergency call, you must press the **PTT** button.

### **Emergency Alert**

An Emergency Alert is not a voice call. It is an emergency notification that is sent to radios that are configured to receive these alerts. The radio sends an emergency alert by using the control channel of the currently registered site. The Emergency Alert is received by radios in the Connect Plus network that are programmed to receive them (no matter which network site they are registered to).

Only one of the Emergency Modes can be assigned to the Emergency button per zone. In addition, each Emergency mode has the following types:

### **Regular**

Radio initiates an Emergency and shows audio and/or visual indicators.

### **Silent**

Radio initiates an Emergency without any audio or visual indicators. The radio suppresses all audio or visual indications of the Emergency until you press the **PTT** button to start a voice transmission.

### **Silent with Voice**

The same as Silent operation, except that the radio also unmutes for some voice transmissions.

#### **5.3.11.1**

### **Responding to an Emergency Call**

The radio does not show that it is receiving an Emergency call. Respond the same way as you would to group calls.

#### **5.3.11.2**

### **Ignore Emergency Revert Call**

This feature enhancement provides an option for your radio to disregard an active Emergency Revert Call.

To enable Ignore Emergency Revert Call, your radio must be configured through the Connect Plus Customer Programming Software (CPCPS).

When the feature is enabled, the radio does not receive any audio on the default Emergency Revert Group ID.

Contact with your dealer for more information.

### 5.3.11.3

## Initiating an Emergency Call



### NOTICE:

If your radio is set to Silent, it does not display any audio or visual indicators during Emergency mode until you press the **PTT** button to initiate a voice transmission.

If your radio is set to Silent with Voice, it does not initially display any audio or visual indicators that the radio is in Emergency mode. However, your radio unmutes for the transmissions of radios responding to your emergency. The emergency indicators only appear once you press the **PTT** button to initiate a voice transmission from your radio.

For both "Silent" and "Silent with Voice" operation, the radio automatically exits silent operation after the Emergency Call is finished.

---

1 Press the programmed **Emergency** button.

2 Press the **PTT** button to initiate a voice transmission on the Emergency group.

When you release the **PTT** button, the Emergency call continues for the time allotted for the Emergency Call Hang Time.

If you press the **PTT** button during this time, the Emergency call continues.

---

### 5.3.11.4

## Initiating an Emergency Call with Voice to Follow

Your radio must be programmed for this type of operation.

When enabled for this operation, when you press the programmed **Emergency** button, and when your radio receives the time slot assignment, the microphone is automatically activated without pressing the **PTT** button. This activated microphone state is also known as "hot mic". The "hot mic" applies to the first voice transmission from your radio during the Emergency call. For subsequent

transmissions in the same Emergency call, you must press the **PTT** button.

- 1 Press the programmed **Emergency** button.
- 2 The microphone remains active for the "hot mic" time specified in your radio codeplug programming.  
During this time, the LED lights up green.
- 3 Press and hold the **PTT** button to talk longer than the programmed duration.

### 5.3.11.5

## Initiating an Emergency Alert



### NOTICE:

If your radio is programmed for "Silent" or "Silent with Voice", it will not provide any audio or visual indications that it is sending an Emergency Alert. If programmed for "Silent", the silent operation continues indefinitely until you press PTT or the button configured for "Emergency Off". If programmed for "Silent with Voice", the radio automatically cancels silent operation when the site controller broadcasts the Emergency Alert.

Press the orange **Emergency** button.

Once the Emergency Alert is successfully sent and is being broadcast for other radios to hear, a positive indicator tone sounds.

### 5.3.11.6

## Exiting Emergency Mode



### NOTICE:

If the Emergency call ends due to the expiration of the Emergency Hang Time, but the emergency condition is not over, press the **Emergency** button again to restart the process.

If you initiate an Emergency Alert by pressing the programmed **Emergency** button, your radio automatically exits Emergency mode after receiving a response from the Connect Plus system.

If you initiate an Emergency call by pressing the programmed **Emergency** button, your radio will be assigned a channel automatically when one becomes available. Once your radio has transmitted a message indicating the emergency, you cannot cancel your Emergency call. However, if you pressed the button by accident or the emergency no longer exists, you may wish

to say this over the assigned channel. When you release the **PTT** button, the Emergency call is discontinued after the Emergency Call Hang Time expires.

If your radio was configured for Emergency with Voice to Follow, use the “hot mic” period to explain your error, then press and release the **PTT** button to discontinue the transmission. The Emergency call is discontinued after the Emergency Call Hang Time expires.

### 5.3.12

## Text Messaging

Your radio is able to receive data, for example a text message, from another radio or a text message application.

There are two types of text messages, Digital Mobile Radio (DMR) Short Text Message and text message. The maximum length of a DMR Short Text Message is 23 characters. The maximum length of a text message is 280 characters, including the subject line. The subject line only appears when you receive messages from e-mail applications.



### NOTICE:

The maximum character length is only applicable for models with the latest software and hardware. For radio models with older software and hardware, the maximum length of a text message is 140 characters. Contact your dealer for more information.

### 5.3.12.1

## Sending Quick Text Messages with the One Touch Access Button

To send a predefined Quick Text message to a predefined alias, press the programmed **One Touch Access** button.

If message is successfully sent, your radio shows the following indications:

- A positive tone sounds.
- The green LED illuminates.

If message fails to be sent, your radio shows the following indications:

- A negative tone sounds.
- The display shows `Message Send Failed`.

If the text message fails to send, the radio returns you to the **Resend** option screen.

### 5.3.13

## Privacy

If enabled, this feature helps to prevent eavesdropping by unauthorized users on a channel by the use of a software-based scrambling solution. The signaling and user identification portions of a transmission are not scrambled.

Your radio must have privacy enabled on the current channel selector position to send a privacy-enabled transmission, although this is not a necessary requirement for receiving a transmission. While on a privacy-enabled channel selector position, the radio is still able to receive clear (unscrambled) transmissions.

Your radio supports Enhanced Privacy.

To unscramble a privacy-enabled call transmission, your radio must be programmed to have the same Key Value and Key ID (for Enhanced Privacy) as the transmitting radio.

If your radio receives a scrambled call that is of a different Key Value and Key ID, you hear nothing at all (Enhanced Privacy).

The LED lights up solid green while the radio is transmitting and blinks green rapidly when the radio is receiving an ongoing privacy-enabled transmission.

You can access this feature by performing one of the following actions:

- Press the programmed **Privacy** button to toggle privacy on or off.



### NOTICE:

Some radio models may not offer this Privacy feature. Check with your dealer or system administrator for more information.

### 5.3.13.1

## Making a Privacy-Enabled (Scrambled) Call

Toggle privacy on using the programmed privacy button. Your radio must have the Privacy feature enabled for the currently selected channel position to send a privacy-enabled transmission. When privacy is enabled for the currently selected channel position, all voice transmissions made by your radio will be scrambled. This includes Group Call, Multigroup Call, talk-back during scanned calls, Site All Call, Emergency Call, and Private Call. Only receiving

radios with the same Key Value and Key ID as your radio will be able to unscramble the transmission.

### 5.3.14

## Password Lock Features

If enabled, this feature only allows you access your radio if the correct password is entered upon powering up.

### 5.3.14.1

## Accessing the Radio from Password

- 1 Power up the radio.

The radio sounds a continuous tone.

---

- 2 Enter your current four-digit password by rotating the Volume/Channel Knob to dial the number. Press and hold the Volume/Channel Knob to move to the next digit. Enter the remaining digits of the password in the same manner.

If the password is correct, the radio proceeds to power up. See [Turning the Radio On on page 21](#).

If the password is incorrect, the radio sounds a continuous tone. Repeat [step 2](#).

After the third incorrect password, A tone sounds and the LED double blinks yellow. The radio enters into locked state.



### NOTICE:

The radio is unable to receive any call in locked state. The use of **Emergency** footswitch cancels password input to access the radio.

---

### 5.3.14.2

## Unlocking the Radio from Locked State

- 1 If your radio was powered down after being in the locked state, power up the radio.

A tone sounds and the LED double blinks yellow.

---

- 2 Wait for 15 minutes.

Your radio restarts the 15 minutes timer for locked state when you power up.

---

- 3 Repeat [step 1](#) and [step 2](#) in [Accessing the Radio from Password on page 105](#).
-

5.3.15

## Bluetooth Operation



**NOTICE:**

If disabled via the CPS, all Bluetooth-related features are disabled and the Bluetooth device database is erased.

This feature allows you to use your radio with a Bluetooth-enabled device (accessory) via a wireless Bluetooth connection. Your radio supports both Motorola Solutions and Commercially available Off-The-Shelf (COTS) Bluetooth-enabled devices.

Bluetooth operates within a range of 10 meters (32 feet) line of sight. This is an unobstructed path between your radio and your Bluetooth-enabled device.

It is not recommended that you leave your radio behind and expect your Bluetooth-enabled device to work with a high degree of reliability when they are separated.

At the fringe areas of reception, both voice and tone quality will start to sound "garbled" or "broken". To correct this problem, simply position your radio and Bluetooth-enabled device closer to each other (within the 10-meter/32 feet defined range) to re-establish clear audio reception. Your radio's Bluetooth function has a maximum power of 2.5 mW (4 dBm) at the 10-meter/32 feet range.

Your radio can support up to 4 simultaneous Bluetooth connections with Bluetooth-enabled devices of unique types. For example, a headset, and a PTT-Only Device (POD).

Refer to your respective Bluetooth-enabled device's user manual for more details on your Bluetooth-enabled device's full capabilities.

### 5.3.15.1

## Finding and Connecting to a Bluetooth Device

Do not turn off your Bluetooth-enabled device during the finding and connecting operation as this cancels the operation.

The radio connects to the Bluetooth-enabled device within range with either the strongest signal strength, or to one which it has connected to before in a prior session.

- 1 Turn on your Bluetooth-enabled device and place it in pairing mode. Refer to respective Bluetooth-enabled device user manual.
-

- 2 On your radio, press the programmed **Bluetooth Connect** button.

A tone sounds and LED blinks yellow.

---

- 3 Your Bluetooth-enabled device may require additional steps to complete the pairing. Refer to respective Bluetooth-enabled device user manual.
- 

If successful, a positive indicator tone sounds.

If unsuccessful, a negative indicator tone sounds.



**NOTICE:**

A pin code may be required to be programmed in your radio before it can pair with some devices. Contact your dealer for more information.

### 5.3.15.2

## Disconnecting from a Bluetooth Device

On your radio, press the programmed **Bluetooth Disconnect** button.

---

A positive indicator tone sounds when disconnected.

### 5.3.15.3

## Switching Audio Route between Internal Radio Speaker and Bluetooth Device

You can toggle audio routing between internal radio speaker and external Bluetooth-enabled accessory.

Press the programmed **Bluetooth Audio Switch** button.

---

A tone sounds when the audio route has switched.

### 5.3.16

## Wi-Fi Operation

This feature allows you to set up and connect to a Wi-Fi network. Wi-Fi supports updates for radio firmware, codeplug, and resources such as language packs and voice announcement.



**NOTICE:**

This feature is applicable to DM4401e only.

Wi-Fi® is a registered trademark of Wi-Fi Alliance®.

Your radio supports WEP/WPA/WPA2-Personal and WPA/WPA2-Enterprise Wi-Fi networks.

### WEP/WPA/WPA2-Personal Wi-Fi network

Uses pre-shared key (password) based authentication.

Pre-shared key can be entered by using the menu or CPS/RM.

### WPA/WPA2-Enterprise Wi-Fi network

Uses certificate-based authentication.

Your radio must be pre-configured with a certificate.



**NOTICE:**

Check with your dealer or system administrator to connect to WPA/WPA2-Enterprise Wi-Fi network.

The programmed **Wi-Fi On or Off** button is assigned by your dealer or system administrator. Check with your dealer or system administrator to determine how your radio has been programmed.

Voice Announcements for the programmed **Wi-Fi On or Off** button can be customized through CPS according to user requirements. Check with your dealer or system administrator for more information.

#### 5.3.16.1

## Turning Wi-Fi On or Off

Press the programmed **Wi-Fi On or Off** button. Voice Announcement sounds Turning On Wi-Fi or Turning Off Wi-Fi.

---

#### 5.3.16.2

### Connecting to a Network Access Point

When you turn on Wi-Fi, the radio scans and connects to a network access point.



**NOTICE:**

The programmed **Wi-Fi Status Query** button is assigned by your dealer or system administrator. Voice Announcements for the programmed **Wi-Fi Status Query** button can be customized according to user requirements by using CPS. Check with your dealer or system administrator to determine how your radio has been programmed.

The WPA-Enterprise Wi-Fi network access points are pre-configured. Check with your dealer or system administrator to determine how your radio has been programmed.

Press the programmed **Wi-Fi Status Query** button for the connection status using Voice Announcement.

Voice Announcement sounds when Wi-Fi is Off, Wi-Fi is On but No Connection, or Wi-Fi is On with Connection.

### 5.3.17

## Utilities

This chapter explains the operations of the utility functions available in your radio.

### 5.3.17.1

## Turning the Radio Tones/Alerts On or Off

You can enable and disable all radio tones and alerts (except for the incoming Emergency alert tone) if needed.

Press the programmed **All Tones/Alerts** button.

| Tone heard ...          | Indication                            |
|-------------------------|---------------------------------------|
| Positive Indicator tone | All tones and alerts are <b>ON</b> .  |
| Negative Indicator tone | All tones and alerts are <b>OFF</b> . |

### 5.3.17.2

## Setting the Power Level

You can customize your radio power setting to high or low for each Connect Plus zone.

**High** enables communication with tower sites in Connect Plus mode located at a considerable distance from you.

**Low** enables communication with tower sites in Connect Plus mode in closer proximity.

Press the programmed **Power Level** button.

| Tone heard ...          | Radio transmitting at ... |
|-------------------------|---------------------------|
| Positive Indicator tone | Low Power                 |
| Negative Indicator tone | High Power                |

### 5.3.17.3

## Voice Announcement

This feature enables the radio to audibly indicate the current Zone or Channel the user has just assigned, or programmable button press. This audio indicator can be customized per customer requirements.

Press the programmed **Voice Announcement** button.

### 5.3.17.4

## Turning Horns/Lights On or Off

This feature needs to be installed through the rear accessory connector of your radio by your dealer.

Your radio is able to notify you of an incoming call via the horns and lights feature. When activated, an incoming call sounds your vehicle's horn and turns on its lights.

Press the programmed **Horns/Lights** button to toggle horns and light feature on or off.

| Tone heard ...          | Radio indicating that ...        |
|-------------------------|----------------------------------|
| Positive Indicator tone | Horns and Lights feature is on.  |
| Negative Indicator tone | Horns and Lights feature is off. |

### 5.3.17.5

## Intelligent Audio

Your radio can automatically adjust its audio volume to overcome background noise in the environment, inclusive of all stationary and non-stationary noise sources. This feature is a Receive-only feature and does not affect Transmit audio.

Press the programmed **Intelligent Audio** button.

### 5.3.17.6

## Turning the Acoustic Feedback Suppressor Feature On or Off

This feature allows you to minimize acoustic feedback in received calls.

Press the programmed **Acoustic Feedback Suppressor** button.

You hear a positive indicator tone, indicating that Acoustic Feedback Suppressor is now enabled.

You hear a negative indicator tone, indicating that the radio is unable to activate Acoustic Feedback Suppressor.

### 5.3.17.7

## Turning GNSS On or Off

Global Navigation Satellite System (GNSS) is a satellite navigation system that determines the radio precise location. GNSS includes Global Positioning System (GPS), Global Navigation Satellite System (GLONASS), and BeiDou Navigation Satellite System (BDS).



### NOTICE:

Selected radio models may offer GPS, GLONASS, and BDS. GNSS constellation is configured by using CPS. Check with your dealer or system administrator to determine how your radio has been programmed.

Press the programmed **GNSS** button to toggle the feature on or off.

---

## Other Systems

---

Features that are available to the radio users under this system are available in this chapter.

### 6.1

## Push-To-Talk Button

---

The Push-to-Talk (**PTT**) button serves two basic purposes:

- While a call is in progress, the **PTT** button allows the radio to transmit to other radios in the call. The microphone is activated when the **PTT** button is pressed.
- While a call is not in progress, the **PTT** button is used to make a new call.

Long press the **PTT** button to talk. Release the **PTT** button to listen.

If the Talk Permit Tone or the PTT Sidetone  is enabled, wait until the short alert tone ends before talking.

 If the Channel Free Indication feature is enabled on your radio (programmed by your dealer), you hear a short alert tone the moment the target radio (the radio that is receiving

your call) releases the **PTT** button, indicating the channel is free for you to respond.

 You hear a continuous Talk Prohibit Tone if your call is interrupted. You should release the **PTT** button if you hear a continuous Talk Prohibit Tone.

### 6.2

## Programmable Buttons

---

Depending on the duration of a button press, your dealer can program the programmable buttons as shortcuts to radio functions.

### Short press

Pressing and releasing rapidly.

### Long press

Pressing and holding for the programmed duration.



### NOTICE:

See [Emergency Operation on page 141](#) for more information on the programmed duration of the **Emergency** button.

## 6.2.1

# Assignable Radio Functions

The following radio functions can be assigned to the programmable buttons.

### Bluetooth® Audio Switch

Toggles audio routing between internal radio speaker and external Bluetooth-enabled accessory.

### Bluetooth Connect

Initiates a Bluetooth find-and-connect operation.

### Bluetooth Disconnect

Terminates all existing Bluetooth connections between your radio and any Bluetooth-enabled devices.

### Bluetooth Discoverable

Enables your radio to enter Bluetooth Discoverable Mode.

### Channel Announcement

Plays zone and channel announcement voice messages for the current channel.

### Emergency

Depending on the programming, initiates or cancels an emergency.

### Ext Public Address (PA)

Toggles audio routing between the connected PA loudspeaker amplifier and the internal PA system of the radio.

### Silence Home Channel Reminder

Mutes the Home Channel Reminder.

### Manual Site Roam <sup>1</sup>

Starts the manual site search.

### Mic AGC

Toggles the internal microphone automatic gain control (AGC) on or off.

### Monitor

Monitors a selected channel for activity.

### Nuisance Channel Delete<sup>1</sup>

Temporarily removes an unwanted channel, except for the Selected Channel, from the scan list. The Selected Channel refers to the selected zone or channel combination of the user from which scan is initiated.

### One Touch Access

Directly initiates a predefined Private, Phone or Group Call, a Call Alert, a Quick Text message, or Home Revert.

---

<sup>1</sup> Not applicable in Capacity Plus.

### **Option Board Feature**

Toggles option board feature(s) on or off for option board-enabled channels.

### **Permanent Monitor<sup>1</sup>**

Monitors a selected channel for all radio traffic until function is disabled.

### **Phone Exit**

Ends a Phone Call.

### **Privacy**

Toggles privacy on or off.

### **Public Address (PA)**

Toggles the internal PA system of the radio on or off.

### **Repeater/Talkaround<sup>1</sup>**

Toggles between using a repeater and communicating directly with another radio.

### **Reset Home Channel**

Sets a new home channel.

### **Silence Home Channel Reminder**

Mutes the Home Channel Reminder.

### **Scan<sup>2</sup>**

Toggles scan on or off.

### **Site Info**

Plays site announcement voice messages for the current site when Voice Announcement is enabled.

### **Site Lock<sup>1</sup>**

When toggled on, the radio searches the current site only. When toggled off, the radio searches other sites in addition to the current site.

### **Status**

Selects the status list menu.

### **Telemetry Control**

Controls the Output Pin on a local or remote radio.

### **Transmit Interrupt Remote Dekey**

Stops an ongoing interruptible call to free the channel.

### **Trill Enhancement**

Toggles trill enhancement on or off.

### **Voice Announcement On/Off**

Toggles voice announcement on or off.

### **Voice Operating Transmission (VOX)**

Toggles VOX on or off.

### **Wi-Fi**

Toggles Wi-Fi on or off.

---

<sup>2</sup> Not applicable in Capacity Plus–Single-Site.

**Zone Toggle**

Allows radio user to toggle between Zone 1 and Zone 2.

**6.2.2****Assignable Settings or Utility Functions**

The following radio settings or utility functions can be assigned to the programmable buttons.

**Tones/Alerts**

Toggles all tones and alerts on or off.

**Channel Up/Down**

Depending on the programming, changes channel to previous or next channel.

**Power Level**

Toggles transmit power level between high and low.

**6.3****Status Indicators**

This chapter explains the status indicators and audio tones used in the radio.

**6.3.1****LED Indicators**

LED indicators show the operational status of your radio.

**Blinking Red**

Radio has failed the self-test upon powering up.

Radio is receiving an emergency transmission.

Radio is transmitting in low battery state.

Radio has moved out of range if Auto-Range Transponder System is configured.

Mute Mode is enabled.

**Solid Green**

Radio is powering up.

Radio is transmitting.

Radio is sending a Call Alert or an emergency transmission.

**Blinking Green**

Radio is receiving a call or data.

Radio is retrieving Over-the-Air Programming transmissions.

Radio is detecting activity over the air.



**NOTICE:**

This activity may or may not affect the programmed channel of the radio due to the nature of the digital protocol.

There is no LED indication when the radio is detecting activity over the air in Capacity Plus.

**Double Blinking Green**

Radio is receiving a privacy-enabled call or data.

**Solid Yellow**

Radio is monitoring a conventional channel.

Radio is in Bluetooth Discoverable Mode.

**Blinking Yellow**

Radio is scanning for activity.

Radio has yet to respond to a Call Alert.

Radio has Flexible Receive List enabled.

All Capacity Plus–Multi-Site channels are busy.

**Double Blinking Yellow**

Radio has Auto Roaming enabled.

Radio is actively searching for a new site.

Radio has yet to respond to a Group Call Alert.

Radio is locked.

Radio is not connected to the repeater while in Capacity Plus.

All Capacity Plus channels are busy.

**6.3.2**

**Tones**

The following are the tones that sound through on the radio speaker.



High Pitched Tone



Low Pitched Tone

**6.3.2.1**

**Indicator Tones**

Indicator tones provide you with audible indications of the status after an action to perform a task is taken.



Positive Indicator Tone



Negative Indicator Tone

6.3.2.2

### Audio Tones

Audio tones provide you with audible indications of the status, or response to data received on the radio.



#### Continuous Tone

A monotone sound. Sounds continuously until termination.



#### Periodic Tone

Sounds periodically depending on the duration set by the radio. Tone starts, stops, and repeats itself.



#### Repetitive Tone

A single tone that repeats itself until it is terminated by the user.



#### Momentary Tone

Sounds once for a short duration set by the radio.

6.4

## Conventional Analog and Digital Modes

---

Each channel in your radio can be configured as a conventional analog or conventional digital channel.

### 1 : Channel Selector Knob

Use the **Channel Rocker** to switch between an analog or a digital channel.

Certain features are unavailable when switching from digital to analog mode.

Your radio also has features available in both analog and digital modes. The minor differences in the way each feature works do **not** affect the performance of your radio.



#### NOTICE:

Your radio also switches between digital and analog modes during a dual mode scan. See [Scan on page 137](#) for more information.

## 6.5

## Icon Information

---

Throughout this publication, the icons described are used to indicate features supported in either the conventional analog or conventional digital mode.



Indicates a conventional **Analog Mode-Only** feature.



Indicates a conventional **Digital Mode-Only** feature.

For features that are available in **both** conventional analog and digital modes, both icons are **not** shown.

For features that are available in a conventional multi-site mode, see [IP Site Connect on page 118](#) for more information.

Selected features are also available on the single-site trunking mode, Capacity Plus-Single Site. See [Capacity Plus-Single-Site on page 119](#) for more information.

Selected features are also available in the multi-site trunking mode, Capacity Plus-Multi-Site. See [Capacity Plus-Multi-Site on page 119](#) for more information.

## 6.6

## IP Site Connect

---

This feature allows your radio to extend conventional communication beyond the reach of a single site by connecting to different available sites by using an Internet Protocol (IP) network. This is a conventional multi-site mode.

When the radio moves out of range from one site and into the range of another, the radio connects to the repeater of the new site to send or receive calls or data transmissions. This is done either automatically or manually depending on your settings.

In an automatic site search, the radio scans through all available sites when the signal from the current site is weak or when the radio is unable to detect any signal from the current site. The radio then locks on to the repeater with the strongest Received Signal Strength Indicator (RSSI) value.

In a manual site search, the radio searches for the next site in the roam list that is currently in range but which may not have the strongest signal and locks on to the repeater.



**NOTICE:**

Each channel can only have either Scan or Roam enabled, not both at the same time.

Channels with this feature enabled can be added to a particular roam list. The radio searches the channels in the roam list during the automatic roam operation to locate the best site. A roam list supports a maximum of 16 channels, including the selected channel.



**NOTICE:**

You cannot manually add or delete an entry in the roam list. Contact your dealer for more information.

## 6.7

### Capacity Plus–Single-Site

---

Capacity Plus–Single-Site is a single-site trunking configuration of the MOTOTRBO radio system, which uses a pool of channels to support hundreds of users and up to 254 Groups. This feature allows your radio to efficiently utilize the available number of programmed channels while in Repeater Mode.

You hear a negative indicator tone if you try to access a feature not applicable to Capacity Plus–Single-Site by using a programmable button press.

Your radio also has features that are available in conventional digital mode, IP Site Connect, and Capacity Plus. However, the minor differences in the way each feature works does not affect the performance of your radio.

Check with your dealer or system administrator for more information on this configuration.

## 6.8

### Capacity Plus–Multi-Site

---

Capacity Plus–Multi-Site is a multi-channel trunking configuration of the MOTOTRBO radio system, combining the best of both Capacity Plus and IP Site Connect configurations.

Capacity Plus–Multi-Site allows your radio to extend trunking communication beyond the reach of a single site, by connecting to different available sites which are connected with an IP network. It also provides an increase in capacity by efficiently utilizing the combined available number of programmed channels supported by each of the available sites.

When the radio moves out of range from one site and into the range of another, it connects to the repeater of the new site to send or receive calls/data transmissions. Depending on your settings, this is done automatically or manually.

If the radio is set to do this automatically, it scans through all available sites when the signal from the current site is weak or when the radio is unable to detect any signal from the current site. It then locks on to the repeater with the strongest RSSI value.

In a manual site search, the radio searches for the next site in the roam list that is currently in range (but which may not have the strongest signal) and locks on to it.

Any channel with Capacity Plus–Multi-Site enabled can be added to a particular roam list. The radio searches these channels during the automatic roam operation to locate the best site.



**NOTICE:**

You cannot manually add or delete an entry to the roam list. Check with your dealer or system administrator for more information.

Similar to Capacity Plus–Single Site, icons of features not applicable to Capacity Plus–Multi-Site are not available in the menu. You hear a negative indicator tone if you try to

access a feature not applicable to Capacity Plus–Multi-Site by using a programmable button press.

6.9

## Zone and Channel Selections

---

This chapter explains the operations to select a zone or channel on your radio. A zone is a group of channels.

Your radio supports up to 32 channels and 2 zones, with a maximum of 32 channels per zone.

Each channel can be programmed with different features and/or support different groups of users.

6.9.1

### Selecting Zones

Follow the procedure to select the required zone on your radio.

Press the programmed **Zone Toggle** button.

One of the following tone sounds:

**Positive Indicator Tone**

Radio is in Zone 2.

## Negative Indicator Tone

Radio is in Zone 1.



### NOTICE:

For all Non-keypad radio, you are recommended to enable Voice Announcement feature for selecting zone. The Voice Announcement feature can only be enabled through CPS.

### 6.9.2

## Selecting Channels

Follow the procedure to select the required channel on your radio.

Do one of the following:

- Use the **Volume/Channel Knob**.
- Press the programmed **Channel Up/Down** buttons.
- Press the programmed **One Touch Access** button.

### 6.10

## Calls

This chapter explains the operations to receive, respond to, make, and stop calls.

You can select a subscriber alias or ID, or group alias or ID after you have selected a channel by using one of these features:

### Programmed One Touch Access Button

This method is used for Group, Private, and Phone Calls only.

You can only have one ID assigned to a **One Touch Access** button with a short or long programmable button press.

### Programmable Button

This method is used for Phone Calls only.

### Volume/Channel Selector Knob

This method manually selects a subscriber alias or ID, or group alias or ID.

### 6.10.1

## Group Calls

Your radio must be configured as part of a group to receive a call from or make a call to the group of users.

#### 6.10.1.1

### Making Group Calls

Follow the procedure to make Group Calls on your radio.

- 1 Do one of the following:
    - Select a channel with the active group alias or ID.
    - Press the programmed **One Touch Access** button.
- 

- 2 Press the **PTT** button to make the call.  
The green LED lights up.
- 

- 3 Release the **PTT** button to listen.  
The green LED lights up when the target radio responds.
- 

- 4  If the Channel Free Indication feature is enabled, you hear a short alert tone the moment the transmitting radio releases the **PTT** button, indicating the channel is free for you to respond. Press the **PTT** button to respond to the call.

The call ends when there is no voice activity for a predetermined period.

---

#### 6.10.1.2

### Responding to Group Calls

To receive a call from a group of users, your radio must be configured as part of that group. Follow the procedure to respond to Group Calls on your radio.

When you receive a Group Call:

- The green LED blinks.
- Your radio unmutes and the incoming call sounds through the speaker.

- 1 Do one of the following:
  -  If the Channel Free Indication feature is enabled, you hear a short alert tone the moment the transmitting radio releases the **PTT** button,

indicating the channel is free for you to respond. Press the **PTT** button to respond to the call.

-  If the Voice Interrupt feature is enabled, press the **PTT** button to interrupt the audio from the transmitting radio and free the channel for you to respond.

The green LED lights up.

---

## 2 Do one of the following:

- Wait for the Talk Permit Tone to end and speak clearly into the microphone if enabled.
  -  Wait for the **PTT** Sidetone to end and speak clearly into the microphone if enabled.
- 

## 3 Release the **PTT** button to listen.

The call ends when there is no voice activity for a predetermined period.

---

### 6.10.2

## Private Calls

A Private Call is a call from an individual radio to another individual radio.

There are two ways to set up a Private Call. The first type sets up the call after performing a radio presence check, while the second type sets up the call immediately. Only one of these types can be programmed to your radio by your dealer.

### 6.10.2.1

## Making Private Calls

Your radio must be programmed to initiate a Private Call. If this feature is not enabled, a negative indicator tone sounds when you initiate the call. Follow the procedure to make Private Calls on your radio.

### 1 Do one of the following:

- Select a channel with the active subscriber alias or ID.
  - Press the programmed **One Touch Access** button.
- 

### 2 Press the **PTT** button to make the call.

The green LED lights up.

---

- 3 Wait for the Talk Permit Tone to end and speak clearly into the microphone if enabled.
- 

- 4 Release the **PTT** button to listen.

The green LED blinks when the target radio responds.

---

- 5  If the Channel Free Indication feature is enabled, you hear a short alert tone the moment the transmitting radio releases the **PTT** button, indicating the channel is free for you to respond. Press the **PTT** button to respond to the call.

The call ends when there is no voice activity for a predetermined period. A tone sounds.

---

### 6.10.2.2

## Responding to Private Calls



Follow the procedure to respond to Private Calls on your radio.

When you receive a Private Call:

- The green LED blinks.

- Your radio unmutes and the incoming call sounds through the speaker.

- 1 Do one of the following:

-  If the Channel Free Indication feature is enabled, you hear a short alert tone the moment the transmitting radio releases the **PTT** button, indicating the channel is free for you to respond. Press the **PTT** button to respond to the call.
-  If the Transmit Interrupt Remote Dekey feature is enabled, press the **PTT** button to stop an ongoing interruptible call and free the channel for you to respond.

The green LED lights up.

---

- 2 Wait for the Talk Permit Tone to end and speak clearly into the microphone if enabled.
- 

- 3 Release the **PTT** button to listen.

The call ends when there is no voice activity for a predetermined period.

---

## 6.10.3

## All Calls

An All Call is a call from an individual radio to every radio on the channel. An All Call is used to make important announcements, requiring full attention from the user. The users on the channel cannot respond to an All Call.

## 6.10.3.1

### Receiving All Calls

When you receive an All Call:

- A tone sounds.
- The green LED blinks.
- Your radio unmutes and the incoming call sounds through the speaker.

An All Call does not wait for a predetermined period before ending.

 If the Channel Free Indication feature is enabled, you hear a short alert tone when the transmitting radio releases the **PTT** button, indicating the channel is free for you to use.

You cannot respond to an All Call.

**NOTICE:**

The radio stops receiving the All Call if you switch to a different channel while receiving the call. You are not able to continue with any menu navigation or editing until the end of an All Call.

## 6.10.3.2

### Making All Calls

Your radio must be programmed for you to make an All Call. Follow the procedure to make All Calls on your radio.

- 1 Select a channel with the active All Call group alias or ID.
- 

- 2 Press the **PTT** button to make the call.

The green LED lights up.

---

- 3 Do one of the following:

- Wait for the Talk Permit Tone to end and speak clearly into the microphone if enabled.
-  Wait for the **PTT** Sidetone to end and speak clearly into the microphone if enabled.

Users on the channel cannot respond to an All Call.

---

## 6.10.4

## Selective Calls

A Selective Call is a call from an individual radio to another individual radio. It is a Private Call on an analog system.

## 6.10.4.1

### Making Selective Calls

Your radio must be programmed for you to initiate a Selective Call. Follow the procedure to make Selective Calls on your radio.

- 1 Select a channel with the active subscriber alias or ID.

---

  - 2 Press the **PTT** button to make the call.  
The green LED lights up.

---

  - 3 Do one of the following:
    - Wait for the Talk Permit Tone to end and speak clearly into the microphone if enabled.
    -  Wait for the **PTT** Sidetone to end and speak clearly into the microphone if enabled.
- 

- 4 Release the **PTT** button to listen.

The green LED lights up when the target radio responds.

---

- 5  If the Channel Free Indication feature is enabled, you hear a short alert tone the moment the transmitting radio releases the **PTT** button, indicating the channel is free for you to respond. Press the **PTT** button to respond to the call.

The call ends when there is no voice activity for a predetermined period.

---

## 6.10.4.2

### Responding to Selective Calls

Follow the procedure to respond to Selective Calls on your radio.

When you receive a Selective Call:

- The green LED blinks.

- Your radio unmutes and the incoming call sounds through the speaker.

1 Press the **PTT** button to respond to the call.

The green LED lights up.

---

2 Wait for the Talk Permit Tone to end and speak clearly into the microphone if enabled.

---

3 Release the **PTT** button to listen.

The call ends when there is no voice activity for a predetermined period. A tone sounds.

---

### 6.10.5

## Phone Calls

A Phone Call is a call from an individual radio to a telephone.

If Phone Call capability is not enabled in your radio:

- Your radio mutes the call.
- Your radio returns to the previous screen when the call ends.

During the Phone Call, your radio attempts to end the call when:

- You press the **One Touch Access** button with the deaccess code preconfigured.
- You enter the deaccess code as the input for extra digits.

During channel access, access or deaccess code, or extra digits transmission, your radio responds to the **On/Off**, **Volume Control**, and **Channel Selector** buttons or knobs only. A tone sounds for every invalid input.



### NOTICE:

Check with your dealer or system administrator for more information.

### 6.10.5.1

## Making Phone Calls

Follow the procedure to make Phone Calls on your radio.

When you attempt to make or end a Phone Call without the access and deaccess codes preconfigured, the attempt fails and a negative indicator tone sounds.

- Press the programmed **One Touch Access** button to the predefined alias or ID.

If the entry for the **One Touch Access** button is empty, a negative indicator tone sounds.

If successful:

- The (Dual Tone Multi Frequency) DMTF Tone sounds.
- You hear the dialling tone of the telephone user.

If unsuccessful:

- A negative indicator tone sounds.
- The phone call fails. Repeat this step.

---

**2** Press the **PTT** button to respond to the call. Release the **PTT** button to listen.

---

**3** Press the programmed **Phone Exit** button to end the call.

If end-call-setup is successful:

- A tone sounds.

If end-call-setup is unsuccessful:

- A negative indicator tone sounds.

- Repeat this step, or wait for the telephone user to end the call.

---

### 6.10.5.2

## Responding to Phone Calls as Group Calls

Follow the procedure to respond to Phone Calls as Group Calls on your radio.

When you receive a Phone Call as a Group Call:

- The green LED blinks.
- Your radio unmutes and the incoming call sounds through the speaker.

If Phone Call capability is not enabled on your radio, your radio mutes the call.

**1** Press the **PTT** button to respond to the call. Release the **PTT** button to listen.

**2** The call ends when there is no voice activity for a predetermined period.

---

## 6.10.5.3

## Responding to Phone Calls as All Calls



When you receive a Phone Call as an All Call, you can respond to or end the call, only if an All Call type is assigned to the channel. Follow the procedure to respond to Phone Calls as All Calls on your radio.

When you receive a Phone Call as an All Call:

- The green LED blinks.
- Your radio unmutes and the incoming call sounds through the speaker.

If Phone Call capability is not enabled on your radio, your radio mutes the call.

- 1 Press the **PTT** button to respond to the call.
- 
- 2 Release the **PTT** button to listen.
- 

## 6.10.5.4

## Responding to Phone Calls as Private Calls

Follow the procedure to respond to Phone Calls as Private Calls on your radio.

When you receive a Phone Call as a Private Call:

- The green LED blinks.
- Your radio unmutes and the incoming call sounds through the speaker.

If Phone Call capability is not enabled on your radio, your radio mutes the call.

- 1 Press the **PTT** button to respond to the call. Release the **PTT** button to listen.
- 
- 2 The call ends when there is no voice activity for a predetermined period.
- 

## 6.10.6

## Initiating Transmit Interrupt

An ongoing call is interrupted, when you perform the following actions:

- Press the **Voice PTT** button.
  - Press the **Emergency** button.
  - Perform data transmission.
- 

### 6.10.7

## Talkaround

This feature allows you to continue communicating when your repeater is non-operational, or when your radio is out of range from the repeater but within the talk range of other radios.

The talkaround setting is retained even after powering down.



#### **NOTICE:**

This feature is not applicable in Capacity Plus.

### 6.10.7.1

## toggling Between Repeater and Talkaround Modes

Follow the procedure to toggle between Repeater and Talkaround modes on your radio.

Press the programmed **Repeater/Talkaround** button.

One of the following tones sounds:

#### **Positive Indicator Tone**

Radio is in talkaround mode.

#### **Negative Indicator Tone**

Radio is in repeater mode.

---

### 6.10.8

## Broadcast Voice Calls

A Broadcast Voice Call is a one-way voice call from any user to an entire talkgroup.

The Broadcast Voice Call feature allows only the call initiating user to transmit to the talkgroup, while the recipients of the call cannot respond (no Call Hang Time).

Your radio must be programmed to allow you to use this feature. Check with your dealer or system administrator for more information.

## 6.10.8.1

## Making Broadcast Voice Calls

Program your radio to make Broadcast Voice Calls.

1 Select a channel with the active group alias or ID.

---

2 Press the **PTT** button to make the call.

The green LED lights up.

---

3 Do one of the following:

- Wait for the Talk Permit Tone to end and speak clearly into the microphone if enabled.
- Wait for the **PTT** Sidetone to end and speak clearly into the microphone if enabled.



**NOTICE:**

Users on the channel cannot respond to Broadcast Voice Calls.

---

The radio returns to the previous menu after the call ends.

## 6.10.8.2

## Making Broadcast Voice Calls by Using the Programmable Number Key

Follow the procedure to make Broadcast Voice Call on your radio by using the programmable number key.

1 On the **Home** screen, long press the programmed number key assigned to the predefined alias or ID.

If the number key is assigned to an entry in a particular mode, this feature is not supported when you long press the number key in another mode.

If the number key is not associated to an entry, a negative indicator tone sounds

---

2 Press the **PTT** button to make the call.

The green LED lights up.

---

See [Assigning Entries to Programmable Number Keys](#) for more information.

## 6.10.8.3

## Making Broadcast Voice Calls by Using the Alias Search

## 6.10.8.4

## Receiving Broadcast Voice Calls

When you receive a Broadcast Voice Call:

- A tone sounds.
- The green LED blinks.
- Your radio unmutes and the incoming call sounds through the speaker.

A Broadcast Voice Call does not wait for a predetermined period before ending.

You cannot respond to a Broadcast Voice Call.

**NOTICE:**

The radio stops receiving the Broadcast Voice Call if you switch to a different channel while receiving the call. You cannot continue with any menu navigation or editing until the end of the Broadcast Voice Call.

## 6.10.9

## Unaddressed Calls

An Unaddressed Call is a group call to one of the 16 predefined group IDs.

This feature is configured using CPS-RM. A contact for one of the predefined IDs is required to initiate and/or receive an Unaddressed Call. Check with your dealer or system administrator for more information.

## 6.10.9.1

## Making Unaddressed Calls

- 1 Select a channel with the active group alias or ID.

---
- 2 Press the **PTT** button to make the call.  
The green LED lights up.

---
- 3 Do one of the following:
  - Wait for the Talk Permit Tone to end and speak clearly into the microphone if enabled.
  - Wait for the **PTT** Sidetone to end and speak clearly into the microphone if enabled.

---
- 4 Release the **PTT** button to listen.  
The green LED lights up when the target radio responds. A momentary tone sounds.

---

- 5 If the Channel Free Indication feature is enabled, you hear a short alert tone the moment the transmitting radio releases the **PTT** button, indicating that the channel is free for you to respond. Press the **PTT** button to respond to the call.

The call ends when there is no voice activity for a predetermined period.

The call initiator can press the programmed **Cancel** button to end a Group Call.

---

#### 6.10.9.2

### Responding to Unaddressed Calls

When you receive an Unaddressed Call:

- The green LED blinks.
- A momentary tone sounds.
- Your radio unmutes and the incoming call sounds through the speaker.

- 1 Do one of the following:

- If the Channel Free Indication feature is enabled, you hear a short alert tone the moment the transmitting radio releases the **PTT** button,

indicating the channel is free for you to respond. Press the **PTT** button to respond to the call.

- If the Voice Interrupt feature is enabled, press the **PTT** button to interrupt the audio from the transmitting radio and free the channel for you to respond.

The green LED lights up.

---

- 2 Do one of the following:

- Wait for the Talk Permit Tone to end and speak clearly into the microphone if enabled.
  - Wait for the **PTT** Sidetone to end and speak clearly into the microphone if enabled.
- 

- 3 Release the **PTT** button to listen.

The call ends when there is no voice activity for a predetermined period.

---

#### 6.10.10

### Open Voice Channel Mode (OVCM)

An Open Voice Channel Mode (OVCM) allows a radio that is not preconfigured to work in a particular system to both receive and transmit during a group or individual call.

The OVCM group call also supports broadcast calls. Program your radio to use this feature. Check with your dealer or system administrator for more information.

### 6.10.10.1

## Making OVCM Calls

Your radio must be programmed for you to make an OVCM Call. Follow the procedure to make OVCM Calls on your radio.

- 1 Press the **PTT** button to make the call.

The green LED lights up.

---

- 2 Do one of the following:

- Wait for the Talk Permit Tone to end and speak clearly into the microphone if enabled.
  - Wait for the **PTT** Sidetone to end and speak clearly into the microphone if enabled.
- 

### 6.10.10.2

## Responding to OVCM Calls

When you receive an OVCM Call:

- The green LED blinks.
- Your radio unmutes and the incoming call sounds through the speaker.

- 1 Do one of the following:

- If the Channel Free Indication feature is enabled, you hear a short alert tone the moment the transmitting radio releases the **PTT** button, indicating the channel is free for you to respond. Press the **PTT** button to respond to the call.
- If the Voice Interrupt feature is enabled, press the **PTT** button to interrupt the audio from the transmitting radio and free the channel for you to respond.

The green LED lights up.

---

- 2 Do one of the following:

- Wait for the Talk Permit Tone to end and speak clearly into the microphone if enabled.
  - Wait for the **PTT** Sidetone to end and speak clearly into the microphone if enabled.
- 

- 3 Release the **PTT** button to listen.

The call ends when there is no voice activity for a predetermined period.

---

## 6.11

# Advanced Features

---

This chapter explains the operations of the features available in your radio.

Your dealer or system administrator may have customized your radio for your specific needs. Check with your dealer or system administrator for more information.

### 6.11.1

## Home Channel Reminder

This feature provides a reminder when the radio is not set to the home channel for a period of time.

If this feature is enabled through CPS, when your radio is not set to the home channel for a period of time, the following occurs periodically:

- The Home Channel Reminder tone and announcement sound.

You can respond to the reminder by performing one of the following actions:

- Return to the home channel.
- Mute the reminder temporarily using the programmable button.
- Set a new home channel using the programmable button.

#### 6.11.1.1

### Muting the Home Channel Reminder

When the Home Channel Reminder sounds, you can temporarily mute the reminder.

Press the programmed **Silence Home Channel Reminder** button.

---

#### 6.11.1.2

### Setting New Home Channels

When the Home Channel Reminder occurs, you can set a new home channel.

Press the **Reset Home Channel** programmable button to set the current channel as the new Home Channel.

---

### 6.11.2

## Remote Monitor

You can use this feature to remotely monitor any audible activity surrounding the target radio.

There are two types of Remote Monitor:

- Remote Monitor without Authentication
- Remote Monitor with Authentication.

Authenticated Remote Monitor is a purchasable feature. In Authenticated Remote Monitor, verification is required when your radio turns on the microphone of a target radio.

When your radio initiates this feature on a target radio with User Authentication, a passphrase is required. The passphrase is preprogrammed into the target radio through CPS.

Both your radio and the target radio must be programmed to allow you to use this feature.

This feature stops after a programmed duration or when there is any user operation on the target radio.

#### 6.11.2.1

## Initiating Remote Monitor

Follow the procedure to initiate Remote Monitor on your radio.

**1** Press the programmed **Remote Monitor** button.

---

**2** Wait for acknowledgment.

If successful:

- A positive indicator tone sounds.

If unsuccessful:

- A negative indicator tone sounds.
- 

### 6.11.3

## Scan Lists

Scan lists are created and assigned to individual channels or groups. Your radio scans for voice activity by cycling through the channel or group sequence specified in the scan list for the current channel or group.

Your radio can support up to 250 scan lists, with a maximum of 16 members in a list.

Each scan list supports a mixture of both analog and digital entries.



**NOTICE:**

This feature is not applicable in Capacity Plus.

#### 6.11.4

### Scan

Your radio cycles through the programmed scan list for the current channel looking for voice activity when you start a scan.



**NOTICE:**

This feature is not applicable in Capacity Plus.

During a dual-mode scan, if you are on a digital channel, and your radio locks onto an analog channel, it automatically switches from digital mode to analog mode for the duration of the call. This is also true for the reverse.

There are two ways of initiating scan:

#### Main Channel Scan (Manual)

Your radio scans all the channels or groups in your scan list. On entering scan, your radio may, depending on the settings, automatically start on the last scanned active channel or group, or on the channel where scan was initiated.

#### Auto Scan (Automatic)

Your radio automatically starts scanning when you select a channel or group that has Auto Scan enabled.



**NOTICE:**

When you configure **Receive Group Message In Scan**, your radio is able to receive group messages from non-home channels. Your radio is able to reply the group messages on home channel but is not able to reply on non-home channels. Check with your dealer or system administrator for more information.

#### 6.11.4.1

### Turning Scan On or Off

Follow the procedure to turn scan on or off on your radio.

Do one of the following:

- Press the programmed **Scan** button to start or stop Scan.
- Turn the **Channel Selector Knob** to select a channel programmed with a scan list.

If scan is enabled:

- The yellow LED blinks.

- A positive indicator tone sounds.

If scan is disabled:

- The LED turns off.
- A negative indicator tone sounds.

### 6.11.4.2

## Responding to Transmissions During Scanning

During scanning, your radio stops on a channel or group where activity is detected. The radio stays on that channel for a programmed duration known as hang time. Follow the procedure to respond to transmissions during scanning.

- 1  If the Channel Free Indication feature is enabled, you hear a short alert tone the moment the transmitting radio releases the **PTT** button, indicating the channel is free for you to respond. Press the **PTT** button during hang time.

The green LED lights up.

- 
- 2 Release the **PTT** button to listen.

The radio returns to scanning other channels or groups if you do not respond within the hang time.

---

### 6.11.4.3

## Deleting Nuisance Channels

If a channel continually generates unwanted calls or noise, (termed a "nuisance" channel), you can temporarily remove the unwanted channel from the scan list. This capability does not apply to the channel designated as the Selected Channel. Follow the procedure to delete nuisance channels on your radio.

- 1 When your radio locks on to an unwanted or nuisance channel, press the programmed **Nuisance Channel Delete** button until you hear a tone.
- 2 Release the programmed **Nuisance Channel Delete** button.

The nuisance channel is deleted.

---

## 6.11.4.4

## Restoring Nuisance Channels

Follow the procedure to restore nuisance channels on your radio.

Do one of the following:

- Turn the radio off and then power it on again.
- Stop and restart a scan using the programmed **Scan** button or menu.
- Change the channel using the **Volume/Channel Knob** or **Channel Up/Down** buttons.

## 6.11.5



## Vote Scan

Vote Scan provides you with wide area coverage in areas where there are multiple base stations transmitting identical information on different analog channels.

Your radio scans analog channels of multiple base stations and performs a voting process to select the strongest received signal. Once that is established, your radio receives transmissions from that base station.

To respond to a transmission during a vote scan, see [Responding to Transmissions During Scanning on page 138](#).

## 6.11.6

## Call Indicator Settings

This feature allows you to configure call or text message ringing tones.

## 6.11.6.1

### Escalating Alarm Tone Volume

The radio can be programmed to continually alert, when a radio call remains unanswered. This is done by automatically increasing the alarm tone volume over time. This feature is known as Escalart.

## 6.11.7

## Call Alert Operation

Call Alert paging enables you to alert a specific radio user to call you back.

This feature is accessible using a programmed **One Touch Access** button.

### 6.11.7.1

## Making Call Alerts

Follow the procedure to make Call Alerts on your radio.

- 1 Press the programmed **One Touch Access** button.  
The green LED lights up.

- 2 Wait for acknowledgment.

If the Call Alert acknowledgment is received, a positive indicator tone sounds.

If the Call Alert acknowledgment is not received, a negative indicator tone sounds.

### 6.11.7.2

## Responding to Call Alerts

When you receive a Call Alert:

- A repetitive tone sounds.

- The yellow LED blinks.

Press the **PTT** button within 4 seconds of receiving a Call Alert page to respond with a Private Call.

---

### 6.11.8

## Mute Mode

Mute Mode provides an option to silence all audio indicators on your radio.

When Mute Mode is initiated, all audio indicators are muted except higher priority features such as emergency operations.

When Mute Mode is exited, your radio resumes playing ongoing tones and audio transmissions.



### **IMPORTANT:**

You can only enable either Face Down or Man Down one at a time. Both features cannot be enabled together.

### 6.11.8.1

## Turning On Mute Mode

Follow the procedure to turn on Mute Mode.

Access this feature by using the programmed **Mute Mode** button.

---

The following occurs when Mute mode is enabled:

- Positive Indicator Tone sounds.
- The red LED light starts blinking and remains blinking until Mute Mode is exited.
- Radio is muted.
- Mute Mode Timer begins counting down the duration that is configured.

#### 6.11.8.2

### Exiting Mute Mode

This feature can be exited automatically once the Mute Mode Timer expires.

Do one of the following to exit Mute mode manually:

- Press the programmed **Mute Mode** button.
  - Press the **PTT** button on any entry.
- 

The following occurs when Mute mode is disabled:

- Negative Indicator Tone sounds.

- The blinking red LED turns off.
- Your radio unmutes and speaker state is restored.
- If the timer has not expired, Mute mode timer is stopped.



#### **NOTICE:**

Mute Mode is also exited if the user transmits voice or switches to an unprogrammed channel.

#### 6.11.9

### Emergency Operation

An Emergency Alarm is used to indicate a critical situation. You are able to initiate an Emergency at any time even when there is activity on the current channel.

Your dealer can set the duration of a button press for the programmed **Emergency** button, except for long press, which is similar with all other buttons:

#### **Short Press**

Duration between 0.05 seconds and 0.75 seconds.

#### **Long Press**

Duration between 1.00 second and 3.75 seconds.

The **Emergency** button is assigned with the Emergency On/Off feature. Check with your dealer for the assigned operation of the **Emergency** button.



**NOTICE:**

If a short press to the **Emergency** button initiates Emergency mode, then a long press to the same enables the radio to exit Emergency mode.

If a long press to the **Emergency** button initiates Emergency mode, then a short press to the same enables the radio to exit Emergency mode.

Your radio supports three Emergency Alarms:

- Emergency Alarm
- Emergency Alarm with Call
- Emergency Alarm with Voice to Follow 



**NOTICE:**

Only one of the Emergency Alarms above can be assigned to the programmed **Emergency** button or the Emergency footswitch.

In addition, each alarm has the following types:

**Regular**

Radio transmits an alarm signal and shows audio and/or visual indicators.

**Silent**

Radio transmits an alarm signal without any audio or visual indicators. Radio receives calls without any sound through the speaker, until the programmed *hot mic* transmission period is over and/or you press the **PTT** button.

**Silent with Voice**

Radio transmits an alarm signal without any audio or visual indicators, but allow incoming calls to sound through the speaker.

### 6.11.9.1

## Receiving Emergency Alarms

When you receive an Emergency Alarm:





- A tone sounds.
- The red LED blinks.



**NOTICE:**

Your radio automatically acknowledges the Emergency Alarm (if enabled).

To return to home screen, perform the following actions:

- a Press .
- b Press  or  to Yes.
- c Press  to select.

The radio returns to the home screen and the display shows the Emergency icon.

### 6.11.9.2

## Exiting Emergency Mode After Receiving the Emergency Alarm

Do one of the following to exit Emergency mode after receiving Emergency alarm:

- Change the channel.
- Press the **Emergency Off** button.
- Power down the radio.

### 6.11.9.3

## Sending Emergency Alarms

This feature allows you to send an Emergency Alarm, a non-voice signal, which triggers an alert indication on a

group of radios. Your radio does not display any audio or visual indicators during Emergency mode when it is set to Silent.

Follow the procedure to send Emergency Alarms on your radio.

- 1 Press the programmed **Emergency On** button.

The green LED lights up.



### NOTICE:

If programmed, the Emergency Search tone sounds. This tone is muted when the radio transmits or receives voice, and stops when the radio exits Emergency mode. The Emergency Search tone can be programmed through CPS.

- 2 Wait for acknowledgment.

If successful:

- The Emergency tone sounds.
- The red LED blinks.

If unsuccessful after all retries have been exhausted:

- A low-pitched tone sounds.

The radio exits the Emergency Alarm mode.

---

#### 6.11.9.4

### Sending Emergency Alarms with Call

This feature allows you to send an Emergency Alarm with Call to a group of radios. Upon acknowledgement by a radio within the group, the group of radios can communicate over a programmed Emergency channel. Follow the procedure to send Emergency Alarms with call on your radio.

- 1 Press the programmed **Emergency On** button or the **Emergency** footswitch.

The green LED lights up.



#### NOTICE:

If programmed, the Emergency Search tone sounds. This tone is muted when the radio transmits or receives voice, and stops when the radio exits Emergency mode. The Emergency Search tone can be programmed by your dealer or system administrator.

---

- 2 Wait for acknowledgment.

If successful:

- The Emergency tone sounds.
  - The red LED blinks.
- 

- 3 Press the **PTT** button to make the call.

The green LED lights up.

---

- 4 Do one of the following:

- Wait for the Talk Permit Tone to end and speak clearly into the microphone if enabled.
  -  Wait for the **PTT** Sidetone to end and speak clearly into the microphone if enabled.
- 

- 5 Release the **PTT** button to listen.
- 

- 6  If the Channel Free Indication feature is enabled, you hear a short alert tone the moment the transmitting radio releases the **PTT** button, indicating the channel is free for you to respond. Press the **PTT** button to respond to the call.
-

- 7 To exit the Emergency mode once the call ends, press the **Emergency Off** button.

If you do not press the **Emergency Off** button to exit the Emergency mode, the red LED blinks and the radio stays in Emergency mode.

---

#### 6.11.9.5

### Emergency Alarms with Voice to Follow

This feature allows you to send an Emergency Alarm with Voice to Follow to a group of radios. Your radio microphone is automatically activated, allowing you to communicate with the group of radios without pressing the **PTT** button. This activated microphone state is also known as *hot mic*.



#### **NOTICE:**

Your radio cannot detect a non-IMPRES microphone that is attached to the rear accessory connector.

When no microphone is detected at the specified programmed connector, your radio checks the alternative connector. Here, your radio gives priority to the detected microphone.

If your radio has Emergency Cycle Mode enabled, repetitions of *hot mic* and receiving period are made for a programmed duration. During Emergency Cycle Mode, received calls sound through the speaker.

If you press the **PTT** button during the programmed receiving period, you hear a prohibit tone, indicating that you should release the **PTT** button. The radio ignores the **PTT** button press and remains in Emergency mode.

If you press the **PTT** button during *hot mic*, and continue to press it after the *hot mic* duration expires, the radio continues to transmit until you release the **PTT** button.

If the Emergency Alarm request fails, the radio does not retry to send the request, and enters the *hot mic* state directly.



#### **NOTICE:**

Some accessories may not support *hot mic*. Check with your dealer or system administrator for more information.

## 6.11.9.6

## Sending Emergency Alarms with Voice to Follow

- 1 Press the programmed **Emergency On** button or the **Emergency** footswitch.

The green LED lights up.

---

- 2 Once the Emergency tone sounds, speak clearly into the microphone.

The radio automatically stops transmitting when:

- The cycling duration between *hot mic* and receiving calls expires, if Emergency Cycle Mode is enabled.
- The *hot mic* duration expires, if Emergency Cycle Mode is disabled.

The red LED blinks. The radio remains in Emergency mode.

---

## 6.11.9.7

## Reinitiating Emergency Mode

Perform one of the following actions:

- Change the channel while the radio is in Emergency mode.

**NOTICE:**

You can reinitiate emergency mode only if you enable emergency alarm on the new channel.

- Press the programmed **Emergency On** button during an emergency initiation or transmission state.
- 

The radio exits the Emergency mode, and reinitiates Emergency.

## 6.11.9.8

## Exiting Emergency Mode After Sending the Emergency Alarm

This feature is only applicable to the radio sending the Emergency Alarm.

Your radio exits Emergency mode when:

- An acknowledgment is received (for Emergency Alarm only).
- All retries to send the alarm have been exhausted.

**NOTICE:**

If your radio is powered off, it exits the Emergency mode. The radio does not reinitiate the Emergency mode automatically when it is turned on again.

Follow the procedure to exit Emergency mode on your radio.

Press the programmed **Emergency Off** button.

---

## 6.11.10

## Text Messaging

Your radio is able to receive data, for example a text message, from another radio or a text message application.

There are two types of text messages, Digital Mobile Radio (DMR) Short Text Message and text message. The maximum length of a DMR Short Text Message is 23 characters. The maximum length of a text message is 280 characters, including the subject line. The subject line only appears when you receive messages from e-mail applications.

**NOTICE:**

The maximum character length is only applicable for models with the latest software and hardware. For radio models with older software and hardware, the maximum length of a text message is 140 characters. Contact your dealer for more information.

## 6.11.10.1

### Quick Text Messages

Your radio supports Quick Text messages as programmed by your dealer.

## 6.11.10.1.1

#### Sending Quick Text Messages

Follow the procedure to send predefined Quick Text messages on your radio to a predefined alias.

- 1 Press the programmed **One Touch Access** button.
- 2 Wait for acknowledgment.  
If successful:
  - The green LED lights up.

- A positive indicator tone sounds.

If unsuccessful:

- A negative indicator tone sounds.
- 

### 6.11.11

## Privacy

This feature helps to prevent eavesdropping by unauthorized users on a channel by the use of a software-based scrambling solution. The signaling and user identification portions of a transmission are not scrambled.

Your radio must have privacy enabled on the channel to send a privacy-enabled transmission, although this is not a necessary requirement for receiving a transmission. While on a privacy-enabled channel, the radio is still able to receive clear or unscrambled transmissions.

Some radio models may not offer Privacy feature, or may have a different configuration. Check with your dealer or system administrator for more information.

Your radio supports two types of privacy, but only one can be assigned to your radio. They are:

- Basic Privacy

- Enhanced Privacy

To unscramble a privacy-enabled call or data transmission, your radio must be programmed to have the same Privacy Key for Basic Privacy, or the same Key Value and Key ID for Enhanced Privacy as the transmitting radio.

If your radio receives a scrambled call that is of a different Privacy Key, or different Key Value and Key ID, you either hear a garbled transmission for Basic Privacy or nothing at all for Enhanced Privacy.

On a privacy-enabled channel, your radio is able to receive clear or unscrambled calls, depending on how your radio is programmed. In addition, your radio may play a warning tone or not, depending on how it is programmed.

The green LED lights up when the radio is transmitting, and blinks rapidly when the radio is receiving an ongoing privacy-enabled transmission.



### **NOTICE:**

This feature is not applicable in Citizens Band channels that are in the same frequency.

### 6.11.11.1

## Turning Privacy On or Off

Follow the procedure to turn privacy on or off on your radio.

Press the programmed **Privacy** button.

### 6.11.12

## Response Inhibit

This feature helps prevent your radio from responding to any incoming transmissions.



#### NOTICE:

Contact your dealer to determine how your radio has been programmed.

If enabled, your radio does not generate any outgoing transmissions in response to incoming transmissions, such as Radio Check, Call Alert, Radio Disable, Remote Monitor, Automatic Registration Service (ARS), Responding to Private Messages, and Sending GNSS location reports.

Your radio cannot receive Confirmed Private Calls when this feature is enabled. However, your radio is able to manually send transmission.

### 6.11.12.1

## Turning Response Inhibit On or Off

Follow the procedure to enable or disable Response Inhibit on your radio.

Press the programmed **Response Inhibit** button.

If successful:

- A positive indicator tone sounds.

If unsuccessful:

- A negative indicator tone sounds.

### 6.11.13

## Multi-Site Control



Your radio is able to search for sites and switch between sites when signal is weak or your radio is unable to detect any signal from the current site.

When the signal is strong, the radio remains on the current site.

This setting is applicable when your current radio channel is part of an IP Site Connect or Capacity Plus–Multi-Site configuration.

Your radio can perform either one of the following site searches:

- Automatic Site Search
- Manual Site Search

If the current channel is a multi-site channel with an attached roam list and is out of range, and the site is unlocked, your radio also performs automatic site search.

### 6.11.13.1

## Enabling Manual Site Search

Press the programmed **Manual Site Roam** button.

- A tone sounds.
- The green LED blinks.

---

If the radio finds a new site, your radio shows the following indications:

- A positive tone sounds.
- The LED extinguishes.

If the radio fails to find a new site, your radio shows the following indications:

- A negative tone sounds.
- The LED extinguishes.

### 6.11.13.2

## Site Lock On/Off

When toggled on, the radio searches the current site only. When toggled off, the radio searches other sites in addition to the current site.

Press the programmed **Site Lock** button.

If the **Site Lock** function is toggled on:

- You hear a positive indicator tone, indicating the radio has locked to the current site.

If the **Site Lock** function is toggled off:

- You hear a negative indicator tone, indicating the radio is unlocked.

---

### 6.11.14

## Lone Worker

This feature prompts an emergency to be raised if there is no user activity, such as any radio button press or channel selection, for a predefined time.

Following no user activity for a programmed duration, the radio pre-warns you using an audio indicator once the inactivity timer expires.

If there is still no acknowledgment by you before the predefined reminder timer expires, the radio initiates an Emergency Alarm.

Only one of the following Emergency Alarms is assigned to this feature:

- Emergency Alarm
- Emergency Alarm with Call
- Emergency Alarm with Voice to Follow 

The radio remains in the emergency state, allowing voice messages to proceed until action is taken. See [Emergency Operation on page 141](#) for more information on ways to exit Emergency.

**NOTICE:**

Check with your dealer or system administrator for more information.

### 6.11.15

## Bluetooth®

This feature allows you to use your radio with a Bluetooth-enabled device (accessory) through a Bluetooth connection. Your radio supports both Motorola Solutions and Commercially available Off-The-Shelf (COTS) Bluetooth-enabled devices.

Bluetooth operates within a range of 10 m (32ft) line of sight. This is an unobstructed path between your radio and your Bluetooth-enabled device. For high degree of reliability, Motorola Solutions recommends to not separate the radio and the accessory.

At the fringe areas of reception, both voice and tone quality start to sound "garbled" or "broken". To correct this problem, position your radio and Bluetooth-enabled device closer to each other (within the 10 m defined range) to re-establish clear audio reception. The Bluetooth function of your radio has maximum power of 2.5 mW (4 dBm) at the 10 m range.

Your radio can support up to three simultaneous Bluetooth connections with Bluetooth-enabled devices of unique types. For example, a headset, a scanner, a sensor device, and a PTT-Only Device (POD).

Refer to the user manual of your respective Bluetooth-enabled device for more details on the full capabilities of your Bluetooth-enabled device.

**NOTICE:**

If disabled through CPS, all Bluetooth-related features are disabled and the Bluetooth device database is erased.

### 6.11.15.1

## Connecting to Bluetooth Devices

Follow the procedure to connect to Bluetooth devices.

Turn on your Bluetooth-enabled device and place it in pairing mode.

Press the programmed **Bluetooth Connect** button.

Your Bluetooth-enabled device may require additional steps to complete the pairing. Refer to the user manual of your Bluetooth-enabled device.

- A tone sounds.
  - The yellow LED blinks.
- 

Wait for acknowledgment.

If successful:

- A positive indicator tone sounds.

If unsuccessful:

- A negative indicator tone sounds.

### 6.11.15.2

## Disconnecting from Bluetooth Devices

Follow the procedure to disconnect from Bluetooth devices.

Press the programmed **Bluetooth Disconnect** button.

A positive indicator tone sounds when the device has been disconnected.

---

### 6.11.15.3

## Switching Audio Route between Internal Radio Speaker and Bluetooth Device

Follow the procedure to toggle audio routing between internal radio speaker and external Bluetooth device.

Press the programmed **Bluetooth Audio Switch** button.

---

A tone sounds when the audio route has switched.

## 6.11.16

## Indoor Location

**NOTICE:**

Indoor Location feature is applicable for models with the latest software and hardware. Check with your dealer or system administrator for more information.

Indoor Location is use to keep track of the location of radio users. When Indoor Location is activated, the radio is in a limited discoverable mode. Dedicated beacons are used to locate the radio and determine its position.

## 6.11.16.1

### Turning Indoor Location On or Off

- Access this feature by using the programmed button.
  - a. Long press the programmed **Indoor Location** button to turn on Indoor Location.

You hear a positive indicator tone.

One of the following scenarios occurs.

- If successful, Indoor Location is turned on.
- If unsuccessful, you hear a negative indicator tone.

- b. Press the programmed **Indoor Location** button to turn off Indoor Location.

You hear a positive indicator tone.

One of the following scenarios occurs.

- If successful, Indoor Location is turned off.
- If unsuccessful, you hear a negative indicator tone.

## 6.11.17

## Auto-Range Transponder System



The Auto-Range Transponder System (ARTS) is an analog-only feature designed to inform you when your radio is out-of-range of other ARTS-equipped radios.

ARTS-equipped radios transmit or receive signals periodically to confirm that they are within range of each other.

Your radio provides indications of states as follows:

**First-Time Alert**

A tone sounds.

### ARTS-in-Range Alert

A tone sounds, if programmed.

### ARTS-Out-of-Range Alert

A tone sounds. The red LED rapidly blinks.



#### NOTICE:

Check with your dealer or system administrator for more information.

#### 6.11.18

## Over-the-Air Programming

Your dealer can remotely update your radio through Over-the-Air Programming (OTAP) without any physical connection. Additionally, some settings can also be configured by using OTAP.

When your radio undergoes OTAP, the green LED blinks.

When your radio receives high volume data:

- The channel becomes busy.
- A negative tone sounds if you press the **PTT** button.

Once the programming update is complete, a tone sounds, and your radio restarts (powers off and on again).

If the programming update is unsuccessful, a tone sounds and the red LED blinks once.



#### NOTICE:

If the programming update is unsuccessful, the software update failure indications appear every time you turn on your radio. Contact your dealer to reprogram your radio with the latest software to eliminate the software update failure indications.

#### 6.11.19

## Transmit Inhibit

Transmit inhibit feature allow users to block all transmission from the radio.



#### NOTICE:

Bluetooth and Wi-Fi features are available in Transmit Inhibit mode.

#### 6.11.19.1

## Enabling Transmit Inhibit

Follow the procedure to enable Transmit Inhibit.

Press the programmed **Transmit Inhibit** button.

---

- A positive indicator tone sounds.



**NOTICE:**

The status of the Transmit Inhibit does not change after the radio powers up.

### 6.11.19.2

## Disabling Transmit Inhibit

Follow the procedure to disable Transmit Inhibit.

Press the programmed **Transmit Inhibit** button.

---

- A negative indicator tone sounds. Transmission is back to normal operation.

### 6.11.20

## Password Lock

You can set a password to restrict access to your radio. Each time you turn on your radio, you are asked to enter the password.

Your radio supports a 4-digit password input.

Your radio is unable to receive calls in locked state.

### 6.11.20.1

## Accessing the Radio by Using Password

Turn on your radio.

- 1 Enter the four-digit password.
  - a To enter the first digit of the password, use the **Channel Selector Knob**.
  - b To move to the next digit, press and hold the **Channel Selector Knob**.
  - c Enter the remaining digit of the password in the same manner.



**NOTICE:**

The use of **Emergency** footswitch cancels password input to access the radio.

---

- 2 Your radio automatically checks the validity of the password when you enter the last digit of the password.
- 

If you enter the password correctly, the radio powers up.

If you enter the wrong password after the first and second attempt, your radio shows the following indications:

- A continuous tone sounds.

Repeat [step 1](#).

If you enter the wrong password after the third attempt, your radio shows the following indications:

- A tone sounds.
- The yellow LED double blinks.
- Your radio enters into locked state for 15 minutes.

Wait for the 15-minute locked state timer to end and then repeat [step 1](#).



**NOTICE:**

If you turn off and turn your radio on again, the 15-minute timer restarts.

### 6.11.20.2

## Unlocking Radios in Locked State

Your radio is unable to receive calls in locked state. Follow the procedure to unlock your radio in locked state.

Do one of the following:

- If the radio is powered on, wait for 15 minutes and then repeat the steps in [Accessing the Radio by Using Password on page 68](#) to access the radio.

- If the radio is powered off, power up the radio. Your radio restarts the 15-minute timer for locked state. A tone sounds. The yellow LED double blinks.

Wait for 15 minutes and then repeat the steps in [Accessing the Radio by Using Password on page 68](#) to access the radio.

### 6.11.21

## Wi-Fi Operation

This feature allows you to set up and connect to a Wi-Fi network. Wi-Fi supports updates for radio firmware, codeplug, and resources such as language packs and voice announcement.



**NOTICE:**

This feature is applicable to DM4401e only.

Wi-Fi® is a registered trademark of Wi-Fi Alliance®.

Your radio supports WEP/WPA/WPA2-Personal and WPA/WPA2-Enterprise Wi-Fi networks.

### WEP/WPA/WPA2-Personal Wi-Fi network

Uses pre-shared key (password) based authentication.

Pre-shared key can be entered by using the menu or CPS/RM.

### WPA/WPA2-Enterprise Wi-Fi network

Uses certificate-based authentication.

Your radio must be pre-configured with a certificate.



#### NOTICE:

Check with your dealer or system administrator to connect to WPA/WPA2-Enterprise Wi-Fi network.

The programmed **Wi-Fi On or Off** button is assigned by your dealer or system administrator. Check with your dealer or system administrator to determine how your radio has been programmed.

Voice Announcements for the programmed **Wi-Fi On or Off** button can be customized through CPS according to user requirements. Check with your dealer or system administrator for more information.

#### 6.11.21.1

### Turning Wi-Fi On or Off

Press the programmed **Wi-Fi On or Off** button. Voice Announcement sounds Turning On Wi-Fi or Turning Off Wi-Fi.

---

#### 6.11.21.2

## Connecting to a Network Access Point

When you turn on Wi-Fi, the radio scans and connects to a network access point.



#### NOTICE:

The programmed **Wi-Fi Status Query** button is assigned by your dealer or system administrator. Voice Announcements for the programmed **Wi-Fi Status Query** button can be customized according to user requirements by using CPS. Check with your dealer or system administrator to determine how your radio has been programmed.

The WPA-Enterprise Wi-Fi network access points are pre-configured. Check with your dealer or system administrator to determine how your radio has been programmed.

Press the programmed **Wi-Fi Status Query** button for the connection status using Voice Announcement.

Voice Announcement sounds when Wi-Fi is Off, Wi-Fi is On but No Connection, or Wi-Fi is On with Connection.

---

## 6.12

# Utilities

---

This chapter explains the operations of the utility functions available in your radio.

### 6.12.1

## Squelch Levels

You can adjust the squelch level to filter out unwanted calls with low signal strength or channels with noise higher than normal background.

### Normal

This is the default setting.

### Tight

This setting filters out unwanted calls and/or background noise. Calls from remote locations may also be filtered out.

#### 6.12.1.1

## Setting Squelch Levels

Follow the procedure to set the squelch levels on your radio.

Press the programmed **Squelch** button.

One of the following tone sounds:

### Positive Indicator Tone

Radio is operating in tight squelch.

### Negative Indicator Tone

Radio is operating in normal squelch.

---

### 6.12.2

## Power Levels

You can customize the power setting to high or low for each channel.

### High

This enables communication with radios located at a considerable distance from you.

### Low

This enables communication with radios in closer proximity.

#### 6.12.2.1

## Setting Power Levels

Follow the procedure to set the power levels on your radio.

Press the programmed **Power Level** button.

If successful:

- The Positive Indicator Tone sounds.
- Radio transmits at low power.

If unsuccessful:

- The Negative Indicator Tone sounds.
- Radio transmits at high power.

### 6.12.3

## Turning Radio Tones/Alerts On or Off

You can enable and disable all radio tones and alerts, if needed, except for incoming Emergency alert tone . Follow the procedure to turn tones and alerts on or off on your radio.

Press the programmed **All Tones/Alerts** button.

If successful:

- The Positive Indicator Tone sounds.
- All tones and alerts are turned on.

If unsuccessful:

- The Negative Indicator Tone sounds.
- All tones and alerts are turned off.

### 6.12.4

## Turning Horns/Lights On or Off

Your radio is able to notify you of an incoming call through the horns and lights feature. When activated, an incoming call sounds the horn and turns on the lights of your vehicle. This feature needs to be installed through your radio rear accessory connector by your dealer. Follow the procedure to turn all horns and lights on or off on your radio.

Press the programmed **Horns/Lights** button.

If successful:

- The Positive Indicator Tone sounds.
- Horns and Lights feature is on.

If unsuccessful:

- The Negative Indicator Tone sounds.
- Horns and Lights feature is off.

### 6.12.5

## Turning Public Address System On or Off

Follow the procedure to enable or disable the internal public address (PA) system of your radio.

Press the programmed **Public Address** button.

One of the following tone sounds:

If successful:

- The Positive Indicator Tone sounds.
- The Public Address system is turned on.

If unsuccessful:

- The Negative Indicator Tone sounds.
  - The Public Address system is turned off.
- 

### 6.12.6

## Turning External Public Address System On or Off

Follow the procedure to enable or disable the external public address (PA) system of your radio.

Press the programmed **Ext Public Address** button.

One of the following tone sounds:

If successful:

- The Positive Indicator Tone sounds.
- The external public address system is turned on.

If unsuccessful:

- The Negative Indicator Tone sounds.
  - The external public address system is turned off.
- 

### 6.12.7

## Voice Operating Transmission

The Voice Operating Transmission (VOX) allows you to initiate a hands-free voice-activated call on a programmed channel. The radio automatically transmits, for a programmed period, whenever the microphone on the VOX-capable accessory detects voice.



### **NOTICE:**

This feature is not applicable in Citizens Band channels that are in the same frequency.

You can enable or disable VOX by doing one of the following:

- Turn the radio off and then power it on again to enable VOX.
- Change the channel by using the **Scroll Up/Down** buttons to enable VOX.
- Change the channel by using the **Volume/Channel Knob** to enable VOX.
- Turn VOX on or off by using the programmed **VOX** button.
- Press the **PTT** button during radio operation to disable VOX.

**NOTICE:**

Turning this feature on or off is limited to radios with this function enabled. Check with your dealer or system administrator for more information.

## 6.12.7.1

## Turning Voice Operating Transmission On or Off

Follow the procedure to turn VOX on or off on your radio.

Press the programmed **VOX** button to toggle the feature on or off.

---

**NOTICE:**

If the Talk Permit Tone is enabled, use a trigger word to initiate the call. Wait for the Talk Permit Tone to finish before speaking clearly into the microphone. See [Turning Talk Permit Tone On or Off](#) for more information.

## 6.12.8

## Turning Voice Announcement On or Off

This feature enables the radio to audibly indicate the current zone or channel the user has just assigned, or the programmable button the user has just pressed.

This audio indicator can be customized according to customer requirements. Follow the procedure to turn Voice Announcement on or off on your radio.

Press the programmed **Voice Announcement** button.

If successful:

- The Positive Indicator Tone sounds.
- All tones and alerts are turned on.

If unsuccessful:

- The Negative Indicator Tone sounds.
  - All tones and alerts are turned off.
- 

### 6.12.9

## Turning Option Board On or Off

Option board capabilities within each channel can be assigned to programmable buttons. A channel can support up to 6 option board features. Follow the procedure to turn option board on or off on your radio.

Press the programmed **Option Board** button.

---

### 6.12.10

## Text-to-Speech

The Text-to-Speech feature can only be enabled by your dealer. If Text-to-Speech is enabled, the Voice Announcement feature is automatically disabled. If Voice Announcement is enabled, then the Text-to-Speech feature is automatically disabled.

This audio indicator can be customized per customer requirements.

### 6.12.10.1

## Setting Text-to-Speech

Follow the procedure to set the Text-to-Speech feature.

Press the programmed **Text-to-Speech** button to listen to the received text message.

---

### 6.12.11

## Turning Intelligent Audio On or Off

Your radio automatically adjusts the audio volume to overcome current background noise in the environment, inclusive of both stationary and non-stationary noise sources. This is a receive-only feature and does not affect transmission audio. Follow the procedure to turn Intelligent Audio on or off on your radio.

Press the programmed **Intelligent Audio** button.

**NOTICE:**

This feature is not applicable during a Bluetooth session.

## 6.12.12

## Turning the Acoustic Feedback Suppressor Feature On or Off

This feature allows you to minimize Acoustic Feedback Suppressor in received calls. Follow the procedure to turn the Acoustic Feedback Suppressor on or off on your radio.

Press the programmed **AF Suppressor** button.

One of the following tone sounds:

### **Positive Indicator Tone**

Acoustic Feedback Suppressor is activated.

### **Negative Indicator Tone**

Acoustic Feedback Suppressor is not activated.

## 6.12.13

## Turning Trill Enhancement On or Off

You can enable this feature when you are speaking in a language that contains many words with alveolar trill (rolling "R") pronunciations. Follow the procedure to turn Trill Enhancement on or off on your radio.

Press the programmed **Trill Enhancement** button to toggle the feature on or off.

If successful:

- The Positive Indicator Tone sounds.
- All tones and alerts are turned on.

If unsuccessful:

- The Negative Indicator Tone sounds.
- All tones and alerts are turned off.

## 6.12.14

## Turning Global Navigation Satellite System On or Off

Global Navigation Satellite System (GNSS) is a satellite navigation system that determines the radio precise

location. GNSS includes Global Positioning System (GPS), Global Navigation Satellite System (GLONASS), and BeiDou Navigation Satellite System (BDS).



**NOTICE:**

Selected radio models may offer GPS, GLONASS, and BDS. GNSS constellation is configured by using CPS. Check with your dealer or system administrator to determine how your radio has been programmed.

---

# Authorized Accessories List

Motorola Solutions provides a list of accessories to improve the productivity of your radio.

**Table 2: Antenna**

| Part Number | Description  |
|-------------|--|
| HAF4019_    | 800/900, 806–941 MHz, 1/4 Wave                               |
| HAF4020_    | 800/900, 806–941 MHz, 3.0dB Gain                             |
| HAF4023_    | 800/900, 806–941 MHz, 5.0dB Gain                             |
| HAF4027_    | 800/900, 806–941 MHz, 5.0dB Gain, Through-Hole Mount, Mini-U |
| PMAD4107_   | UHF, 350–400 MHz, 1/4 Wave, Through-Hole Mount, BNC          |

**Table 3: Antenna for use with base PMAN4003\_ only**

| Part Number           | Description                                       |
|-----------------------|---|
| HAE6027_              | UHF, 494–512 MHz, 3.0 dB Gain, Through-Hole Mount |
| HAE6028_              | UHF, 470–494 MHz, 3.0 dB Gain, Through-Hole Mount |
| HAE6029_ <sup>3</sup> | UHF, 403–527 MHz, 2.0 dB Gain, Through-Hole Mount |
| HAE6030_              | UHF, 470–527 MHz, 1/4 Wave, Through-Hole Mount    |
| PMAE4039_             | UHF, 403–430 MHz, 1/4 Wave                        |
| PMAE4041_             | UHF, 450–470 MHz, 1/4 Wave                        |
| PMAE4040_             | UHF, 406–420 MHz, 3.5 dB Gain                     |
| PMAE4042_             | UHF, 450–470 MHz, 3.5 dB Gain                     |
| PMAE4043_             | UHF, 450–470 MHz, 5.0 dB Gain                     |

<sup>3</sup> Use with standard antenna bases

## Limited Warranty

---

### MOTOROLA SOLUTIONS COMMUNICATION PRODUCTS

#### I. WHAT THIS WARRANTY COVERS AND FOR HOW LONG:

Motorola Solutions, Inc. ("Motorola Solutions") warrants the Motorola Solutions manufactured Communication Products listed below ("Product") against defects in material and workmanship under normal use and service for a period of time from the date of purchase as scheduled below:

|                     |               |
|---------------------|---------------|
| Mobile Radios       | Two (2) Years |
| Product Accessories | One (1) Year  |

Motorola Solutions, at its option, will at no charge either repair the Product (with new or reconditioned parts), replace it (with a new or reconditioned Product), or refund the purchase price of the Product during the warranty period provided it is returned in accordance with the terms of this warranty. Replaced parts or boards are warranted

for the balance of the original applicable warranty period. All replaced parts of Product shall become the property of Motorola Solutions.

This express limited warranty is extended by Motorola Solutions to the original end user purchaser only and is not assignable or transferable to any other party. This is the complete warranty for the Product manufactured by Motorola Solutions. Motorola Solutions assumes no obligations or liability for additions or modifications to this warranty unless made in writing and signed by an officer of Motorola Solutions.

Unless made in a separate agreement between Motorola Solutions and the original end user purchaser, Motorola Solutions does not warrant the installation, maintenance or service of the Product.

Motorola Solutions cannot be responsible in any way for any ancillary equipment not furnished by Motorola Solutions which is attached to or used in connection with the Product, or for operation of the Product with any ancillary equipment, and all such equipment is expressly excluded from this warranty. Because each system which may use the Product is unique, Motorola Solutions disclaims liability for range, coverage, or operation of the system as a whole under this warranty.

## II. GENERAL PROVISIONS

This warranty sets forth the full extent of Motorola Solutions responsibilities regarding the Product. Repair, replacement or refund of the purchase price, at Motorola Solutions option, is the exclusive remedy. THIS WARRANTY IS GIVEN IN LIEU OF ALL OTHER EXPRESS WARRANTIES. IMPLIED WARRANTIES, INCLUDING WITHOUT LIMITATION, IMPLIED WARRANTIES OF MERCHANTABILITY AND FITNESS FOR A PARTICULAR PURPOSE, ARE LIMITED TO THE DURATION OF THIS LIMITED WARRANTY. IN NO EVENT SHALL MOTOROLA SOLUTIONS BE LIABLE FOR DAMAGES IN EXCESS OF THE PURCHASE PRICE OF THE PRODUCT, FOR ANY LOSS OF USE, LOSS OF TIME, INCONVENIENCE, COMMERCIAL LOSS, LOST PROFITS OR SAVINGS OR OTHER INCIDENTAL, SPECIAL OR CONSEQUENTIAL DAMAGES ARISING OUT OF THE USE OR INABILITY TO USE SUCH PRODUCT, TO THE FULL EXTENT SUCH MAY BE DISCLAIMED BY LAW.

## III. STATE LAW RIGHTS:

SOME STATES DO NOT ALLOW THE EXCLUSION OR LIMITATION OF INCIDENTAL OR CONSEQUENTIAL DAMAGES OR LIMITATION ON HOW LONG AN IMPLIED

WARRANTY LASTS, SO THE ABOVE LIMITATION OR EXCLUSIONS MAY NOT APPLY.

This warranty gives specific legal rights, and there may be other rights which may vary from state to state.

## IV. HOW TO GET WARRANTY SERVICE

You must provide proof of purchase (bearing the date of purchase and Product item serial number) in order to receive warranty service and, also, deliver or send the Product item, transportation and insurance prepaid, to an authorized warranty service location. Warranty service will be provided by Motorola Solutions through one of its authorized warranty service locations. If you first contact the company which sold you the Product (for example, dealer or communication service provider), it can facilitate your obtaining warranty service. You can also call Motorola Solutions at 1-800-927-2744.

## V. WHAT THIS WARRANTY DOES NOT COVER

- 1 Defects or damage resulting from use of the Product in other than its normal and customary manner.

- 2 Defects or damage from misuse, accident, water, or neglect.
- 3 Defects or damage from improper testing, operation, maintenance, installation, alteration, modification, or adjustment.
- 4 Breakage or damage to antennas unless caused directly by defects in material workmanship.
- 5 A Product subjected to unauthorized Product modifications, disassembles or repairs (including, without limitation, the addition to the Product of non-Motorola Solutions supplied equipment) which adversely affect performance of the Product or interfere with Motorola Solutions normal warranty inspection and testing of the Product to verify any warranty claim.
- 6 Product which has had the serial number removed or made illegible.
- 7 Rechargeable batteries if:
  - any of the seals on the battery enclosure of cells are broken or show evidence of tampering.
  - the damage or defect is caused by charging or using the battery in equipment or service other than the Product for which it is specified.
- 8 Freight costs to the repair depot.
- 9 A Product which, due to illegal or unauthorized alteration of the software/firmware in the Product, does not function in accordance with Motorola Solutions published specifications or the FCC certification labeling in effect for the Product at the time the Product was initially distributed from Motorola Solutions.
- 10 Scratches or other cosmetic damage to Product surfaces that does not affect the operation of the Product.
- 11 Normal and customary wear and tear.

## VI. PATENT AND SOFTWARE PROVISIONS

Motorola Solutions will defend, at its own expense, any suit brought against the end user purchaser to the extent that it is based on a claim that the Product or parts infringe a United States patent, and Motorola Solutions will pay those costs and damages finally awarded against the end user purchaser in any such suit which are attributable to any such claim, but such defense and payments are conditioned on the following:

- 1 Motorola Solutions will be notified promptly in writing by such purchaser of any notice of such claim,

- 2 Motorola Solutions will have sole control of the defense of such suit and all negotiations for its settlement or compromise, and
- 3 Should the Product or parts become, or in Motorola Solutions opinion be likely to become, the subject of a claim of infringement of a United States patent, that such purchaser will permit Motorola Solutions, at its option and expense, either to procure for such purchaser the right to continue using the Product or parts or to replace or modify the same so that it becomes non-infringing or to grant such purchaser a credit for the Product or parts as depreciated and accept its return. The depreciation will be an equal amount per year over the lifetime of the Product or parts as established by Motorola Solutions.

Motorola Solutions will have no liability with respect to any claim of patent infringement which is based upon the combination of the Product or parts furnished hereunder with software, apparatus or devices not furnished by Motorola Solutions, nor will Motorola Solutions have any liability for the use of ancillary equipment or software not furnished by Motorola Solutions which is attached to or used in connection with the Product. The foregoing states the entire liability of Motorola Solutions with respect to infringement of patents by the Product or any parts thereof.

Laws in the United States and other countries preserve for Motorola Solutions certain exclusive rights for copyrighted Motorola Solutions software such as the exclusive rights to reproduce in copies and distribute copies of such Motorola Solutions software. Motorola Solutions software may be used in only the Product in which the software was originally embodied and such software in such Product may not be replaced, copied, distributed, modified in any way, or used to produce any derivative thereof. No other use including, without limitation, alteration, modification, reproduction, distribution, or reverse engineering of such Motorola Solutions software or exercise of rights in such Motorola Solutions software is permitted. No license is granted by implication, estoppel or otherwise under Motorola Solutions patent rights or copyrights.

## VII. GOVERNING LAW

This Warranty is governed by the laws of the State of Illinois, U.S.A.

## VIII. For Australia Only

This warranty is given by Motorola Solutions Australia Pty Limited (ABN 16 004 742 312) of Tally Ho Business Park, 10 Wesley Court. Burwood East, Victoria.

Our goods come with guarantees that cannot be excluded under the Australia Consumer Law. You are entitled to a replacement or refund for a major failure and compensation for any other reasonably foreseeable loss or damage. You are also entitled to have the goods repaired or replaced if the goods fail to be of acceptable quality and the failure does not amount to a major failure.

Motorola Solutions Australia's limited warranty above is in addition to any rights and remedies you may have under the Australian Consumer Law. If you have any queries, please call Motorola Solutions Australia at 1800 457 439. You may also visit our website: [http://www.motorolasolutions.com/XA-EN/Pages/Contact\\_Us](http://www.motorolasolutions.com/XA-EN/Pages/Contact_Us) for the most updated warranty terms.

[www.motorolasolutions.com/mototrbo](http://www.motorolasolutions.com/mototrbo)

MOTOROLA, MOTO, MOTOROLA SOLUTIONS and the Stylized M Logo are trademarks or registered trademarks of Motorola Trademark Holdings, LLC and are used under license. All other trademarks are the property of their respective owners. © 2012 and 2021 Motorola Solutions, Inc. All rights reserved.

